



















Commonwealth **Annual Report**  
Director of Public Prosecutions **1995-96**

 Annual Report 1995-96

-  [Introduction](#)
-  [Office of the Commonwealth Director of Public Prosecutions](#)
-  [Compliance statement](#)
-  [Director's overview](#)
-  [Chapter 1 - Office of the DPP](#)
-  [Chapter 2 - Exercise of Statutory Powers](#)
-  [Chapter 3 - General Prosecutions](#)
-  [Chapter 4 - Corporate Prosecutions](#)
-  [Chapter 5 - Criminal Assets](#)
-  [Chapter 6 - Law Reform and Other Issues](#)
-  [Chapter 7 - Resource Management](#)
-  [Chapter 8 - Prosecution and Assets Recovery Statistics](#)
-  [Appendix](#)
-  [Glossary](#)
-  [Compliance Index](#)
-  [Independent Audit Report](#)
-  [Financial Statements 1995-96](#)





## Commonwealth Director of Public Prosecutions

### Annual Report 1995-96



---

Commonwealth of Australia 1996  
ISSN 1043-6420

This work is copyright. Apart from any use as permitted under the *Copyright Act 1968*, no part may be reproduced by any process without written permission from the Australian Government Publishing Service.

---

## Commonwealth Director of Public Prosecutions

The Hon. Darryl Williams QC MP  
Attorney-General  
Parliament House  
CANBERRA ACT 2600

My dear Attorney,

I have the honour to submit my report on the operations of the Office of the Director of Public Prosecutions for the year ending 30 June 1996, in accordance with [section 33\(1\) of the \*Director of Public Prosecutions Act 1983\*](#).

Yours faithfully,



MICHAEL ROZENES QC  
Director  
October 1996

---



[Return to the Annual Report Table of Contents](#)



[Return to the DPP Home Page](#)

---



## Office of the Commonwealth Director of Public Prosecutions

### *Head Office*

Director: Michael Rozenes QC  
Associate Director: Edwin J. Lorkin  
First Deputy Director: Peter Walshe  
4 Marcus Clarke St, Canberra City ACT 2601  
Tel: 06 2065666, Fax: 06 2065684  
GPO Box 3104, CANBERRA CITY 2601

---

### *Sydney Office*

Deputy Director: Tony Wadick  
Level 35, Pacific Power Building, 201 Elizabeth St  
SYDNEY NSW 2000  
Tel: 02 9321 1100, Fax: 02 9264 8241,  
Locked Bag A4020, SYDNEY SOUTH NSW 2000

---

### *Melbourne Office*

Deputy Director: Mark Pedley  
22nd Floor ACI House, 200 Queen Street  
MELBOURNE VIC 3000,  
Tel: 03 9605 4333, Facsimile: 03 9670 4295  
GPO Box 21A, MELBOURNE VIC 3001

---

### *Brisbane Office*

Deputy Director: Paul Evans  
19th Floor MLC Court, 15 Adelaide Street,  
BRISBANE QLD 4000  
Tel: 07 3224 9444, Fax: 07 32294124  
GPO Box 847, BRISBANE QLD 4001

---

### *Townsville sub-office*

Principal Legal Officer: Clive Porritt  
3rd Floor 188 Wills Street  
TOWNSVILLE QLD 4810  
Tel: 077 727 177, Facsimile: 077 721 358  
PO Box 1233 TOWNSVILLE QLD 4810

---

***Perth Office***

Deputy Director:

Ian Bermingham  
8th Floor 66 St Georges Terrace, PERTH WA 6000  
Tel: 09 264 7264, Facsimile: 09 264 7266  
GPO Box B92, PERTH WA 6001

---

***Adelaide Office***

Deputy Director

Paul Foley  
11th Floor Sun Alliance House, 45 Grenfell Street,  
SA 5000  
Tel: 08 238 2600, Facsimile: 08 231 8257  
GPO Box 2562, ADELAIDE SA 5001

---

**Australian Government Solicitors' Office**

***Hobart Office***

4th Floor Commonwealth Law Courts Bldg,  
39-41 Davey Street,  
HOBART TAS 7000  
Tel: 002 321 830, Fax: 002 321 888  
GPO Box 366D, HOBART TAS 7001

***Darwin Office***

9th Floor National Mutual Centre, 11-13 Cavenagh Street,  
DARWIN NT 0800  
Tel: 08 89431444, Fax: 08 89431420  
Locked Bag 12, DARWIN NT 0801

---



[Return to the Annual Report Table of Contents](#)



[Return to the DPP Home Page](#)

---



## Compliance statement

This report has been prepared for the purpose of [section 33 of the \*Director of Public Prosecutions Act 1983\*](#).

Section 33(1) requires that the Director of Public Prosecutions shall, as soon as practicable after 30 June each year, prepare and furnish a report to the Attorney-General with regard to the operations of the Office during the year.

Section 33(2) provides that the Attorney-General shall cause a copy of the report to be laid before each House of the Parliament within 15 sitting days of receipt.

The report has been prepared in accordance with guidelines for the preparation of annual reports that were tabled in the House of Representatives on 10 April 1991 and in the Senate on 11 April 1991.

As aids to access, the report includes a table of contents, a glossary, an alphabetical index and a compliance index showing where each item that is required under the guidelines and which is applicable to the DPP, can be found.

Anyone interested in knowing more about the DPP should have regard to the following documents:

- *Prosecution Policy of the Commonwealth*;
- *DPP Corporate Plan*;
- *DPP Information Booklet*; and
- *Program Performance Statement for the Attorney-Generals Portfolio*.

The DPP also has a homepage on the Internet. It can be accessed at <http://www.nla.gov.au/dpp/dpphp.html>. The homepage carries the most recent Annual Report, copies of speeches and some general information about the DPP. The Email address is [cdpphpg@spirit.com.au](mailto:cdpphpg@spirit.com.au).

The DPP has also produced an information video entitled *Prosecuting in the Public Interest*, which outlines the work of the office.

Copies of the documents can be obtained by writing to the DPP at any of the addresses that appear at the start of this report. Copies of the video are also available from each office.

Enquiries can also be directed to the Librarian, 06 206 5683 (Telephone) or 06 206 5685 (Facsimile)



[Return to the Annual Report Table of Contents](#)



[Return to the DPP Home Page](#)



## Director's overview

This is my fifth and last Annual Report as Director of Public Prosecutions. My appointment as Director comes to an end on 31 January 1997.

I have enjoyed my time as Director. It has been an interesting and challenging period. I have had the benefit of working with some very good people and the opportunity to do a job which is really worthwhile. I will miss the work and I will miss the people. I wish my successor well. I am sure that he or she will get the same measure of support that I have received from the staff of the DPP and will derive the same level of satisfaction from the work.

The past year saw a change of government following the election in March 1996 with a resultant change of Attorney-General. The Office developed good relations with the former Attorney-General, Michael Lavarch, and the former Minister for Justice, Duncan Kerr. I would like to thank both of them for the support they showed for the DPP and wish them well for the future. I am certain that the Office will have equally good relations with the new Attorney-General and Minister for justice, Daryl Williams QC.



The challenge that now faces the DPP, as it faces other Commonwealth agencies, is to meet the budget targets set by government while maintaining the level of performance expected by government and the Australian community.

The challenge comes at a time when the cases we prosecute are becoming more complex, as law enforcement agencies concentrate their attention at the serious end of the market, and when defendants, or at least those who are well resourced, are making ever more use of collateral procedures that tie up the criminal process. The DPP needs to get the best value out of the resources available to it. At the same time, we need to be able to match the effort put in by defendants. It is important to ensure that no one in Australia can avoid the consequences of criminal conduct simply because they have a large sum of money to spend on their legal defence. Australia cannot have different systems of justice for the rich and the poor and the DPP cannot afford to become a cut-rate prosecution service. I am confident that the DPP will continue to meet the challenge.

I have been pleased to see the progress made by the Heads of Commonwealth Operational Law Enforcement Agencies, otherwise known as HOCOLEA, in clearing the way for greater cooperation within the law enforcement community. I would like to thank the other members of HOCOLEA for their assistance over the past year and for the positive way in which they have approached the issues that affect us all. Law enforcement depends heavily on cooperation between law enforcement agencies. All involved in the process have different roles to play, and different needs and priorities. However, the process works best when all agencies participate in working towards agreed goals.

I have also been pleased to see a continued move by DPP lawyers to have a greater role in providing assistance and support to investigative agencies. It is important to ensure that there is a separation between the investigation and prosecuting functions. The public interest requires that the decision to prosecute is made, and is seen to be made, by an agency which stands apart from the investigation and which is not at risk of developing pre-formed views about the guilt or innocence of the defendant. However, it is also important that those charged with investigating large and complex cases have access to advice and support from the DPP to help them develop an investigation strategy which is likely to result in an effective prosecution and to provide advice on legal and evidential issues that arise in the course of the investigation. It is in the interest of all concerned that the investigative process is appropriately focused.

The past year saw the establishment of units, in the Sydney and Melbourne offices, to provide direct liaison in tax and social security cases. The intention is to give investigators from the Australian Taxation Office and the Department of Social Security a greater level of support and to develop cores of specialist expertise within the DPP.

There may be further moves towards specialisation within the DPP, although there are practical limits to the extent which DPP lawyers can specialise, especially in smaller offices or in the more esoteric areas of legal practice.

The year also saw the publication in June 1996 of the Report to government by the National Commission of Audit. The Report made some comments in relation to the DPP.

The report acknowledged the importance of retaining an independent Director of Public Prosecutions to determine whether or not to prosecute, which is to be welcomed. However, it went on to state that "there appears no reason why the action leading to that decision and the subsequent prosecution activity ... should not be made contestable and contracted out".

There are fundamental difficulties with such a proposal. Chief among those are the risk that the Director would lose control of the prosecution process if he or she lost control over the prosecutors. While the DPP currently prosecutes the majority of its caseload using in-house resources, it retains barristers from the private bar, acting on instructions from DPP officers, in those cases that require skills that are not available in-house. However, there is a difference between bringing in outside skills when they are needed and handing over effective responsibility for the conduct of the prosecution process. The proposal would affect the Director's ability to ensure that the prosecution system operated consistently and fairly.

This very issue, amongst others, was addressed in March 1994 in a comprehensive Review of the Office conducted over a six months period by senior representatives of the DPP, the Attorney-General's Department and the Department of Finance. The Review found that a departure from the present system was not warranted and the prospect of potential savings from doing so was doubtful.

A cornerstone of our great democracy is the criminal justice system. As long as it is able to fairly and justly resolve disputes between the citizen and the State it will retain public confidence in the administration of justice and serve us well. That confidence will only be earned when the process of prosecution is conducted and seen to be conducted in the public interest by an independent prosecutor without fear or favour. We presently have such a system and we should guard it jealously.

It remains to thank the staff of my Office for their hard work and the support they have given me. I have made many friends and I will miss them all. I would also like to thank my State counterparts and the heads of the agencies we deal with for their cooperation. It is especially gratifying to note that the good relations we have built up with the Attorney-General's Department have continued.



*Michael Rozenes QC*  
*Commonwealth Director of Public Prosecutions*



[Return to the Annual Report Table of Contents](#)









[Return to the DPP Home Page](#)





Commonwealth **Annual Report**  
Director of Public Prosecutions **1995-96**

 [Annual Report 1995-96](#)

-   [Chapter 1 - Office of the DPP](#)
-  [Establishment](#)
-  [Vision And Corporate Plan](#)
-  [Role](#)
-  [Functions And Powers](#)
-  [Organisation](#)

---

 [Return to the Annual Report Table of Contents](#)

 [Return to the DPP Home Page](#)

---



## Chapter 1

### Office of the DPP

---



## Establishment

The DPP was established under the *Director of Public Prosecutions Act 1983* and began operations in 1984. The Office is headed by a Director, who is appointed for a statutory term of up to seven years, and an Associate Director.

The current Director, Michael Rozenes QC, was appointed from the Victorian Bar for a period of three years commencing on 1 February 1992. His appointment was renewed for a further two years on 1 February 1995. There is provision under section 18 of the DPP Act for the Director to be appointed subject to terms and conditions. No terms or conditions were specified in the case of the present Director.

The current Associate Director, Edwin J. Lorkin, was appointed for a period of three years commencing on 1 July 1992. His appointment was renewed for a period of two years on 30 June 1995.

The DPP is within the portfolio of the Commonwealth Attorney-General, but the Office operates independently of the political process.

Under section 8 of the DPP Act the Attorney-General has power to issue guidelines and directions to the DPP. That can only be done after there has been consultation between the Attorney-General and the Director. In addition, any direction or guideline must be in writing and a copy must be published in the *Gazette* and laid before each House of Parliament within 15 sitting days.

There were no directions issued under section 8 during the last year.

---

 [Return to the Annual Report Table of Contents](#)

 [Return to the DPP Home Page](#)

---



## Vision And Corporate Plan

The DPP's vision is to provide a fair, effective and efficient prosecution service to the Commonwealth and the people of Australia.

The corporate plan identifies the following objectives:

- to prosecute alleged offences against the criminal law of the Commonwealth, in appropriate matters, in a manner which is fair and just;
- to ensure that offenders are deprived of the proceeds and benefits of criminal activity and to ensure the pursuit of civil remedies;
- to assist and cooperate with other agencies to ensure that law enforcement activities are effective;
- to contribute to the improvement of the Commonwealth criminal law and the criminal justice system generally;
- to preserve and enhance public confidence in the prosecution process and criminal justice system; and
- to manage resources efficiently and provide an effective service to the Commonwealth.

The corporate plan is designed to advance social justice by deterring and discouraging breaches of Commonwealth law.

The current corporate plan was settled in 1989 and is due to be reviewed as soon as other priorities allow.



[Return to the Annual Report Table of Contents](#)



[Return to the DPP Home Page](#)



## Role

The primary role of the DPP is to prosecute offences against Commonwealth law, including the Corporations Law, and to recover the proceeds of Commonwealth crime.

The majority of Commonwealth prosecutions, other than the occasional private prosecution, are conducted by the DPP. The remaining cases consist mainly of high-volume matters which, for reasons of convenience, are conducted by other agencies under arrangement with the DPP. State authorities also conduct some Commonwealth prosecutions, again for reasons of convenience.

The DPP is also responsible for the conduct of prosecutions for offences against the laws of Jervis Bay and Australia's external territories, other than Norfolk Island.

The DPP's practice in relation to the recovery of criminal assets is described later in this report. In general terms, the DPP's role is to ensure that Commonwealth offenders who have derived significant financial benefits, and who have accumulated assets, are not only prosecuted but are also stripped of those assets.

The DPP is not an investigative agency. It can only prosecute when there has been an investigation by the Australian Federal Police or another investigative agency. However, the DPP regularly provides advice and other assistance during the investigative stage, particularly in large and complex matters.

The Commonwealth's main investigative agencies are the Australian Federal Police, the National Crime Authority and the Australian Securities Commission. However, many other agencies have an investigative role and the DPP receives briefs of evidence from, and provides legal advice to, a wide range of different agencies.

All decisions in the prosecution process are made in accordance with the guidelines laid down in the *Prosecution Policy of the Commonwealth*, which is available from any DPP office listed at the front of this report.



[Return to the Annual Report Table of Contents](#)



[Return to the DPP Home Page](#)



## Functions And Powers

The DPP is created by statute and only has those functions and powers which are given to the Director by legislation. Those functions and powers are to be found in sections 6 and 9 of the DPP Act and in specific legislation like the *Proceeds of Crime, Act 1987*.

The main functions of the Director have already been discussed. The Director also has a number of miscellaneous functions including:

- to prosecute indictable offences against State law where, with the consent of the Attorney-General, he is authorised to do so under the laws of that State;
- to conduct committal proceedings and summary prosecutions for offences against State law where a Commonwealth officer is the informant;
- to assist coroners in inquests and inquiries under Commonwealth law;
- to appear in extradition proceedings and proceedings under the *Mutual Assistance in Criminal Matters Act 1987*; and
- to apply for superannuation forfeiture orders under Commonwealth law.

The Director also has the function under section 6(1)(g) of the DPP Act to recover pecuniary penalties in matters specified in an instrument signed by the Attorney-General. Among other things, this provision covers cases where Commonwealth law is enforceable by quasi-criminal proceedings rather than prosecution.

To date there has only been one instrument signed under section 6(1)(g) which has general application. That instrument was signed on 3 July 1985 and, among other things, it ensures that the DPP has power to conduct all prosecutions under taxation laws.

The DPP does not conduct prosecutions under the *Customs Act 1901*, except in the case of narcotics offences. The responsibility for prosecuting non-narcotic matters, which are enforceable by quasi-criminal proceedings, rests with the Australian Government Solicitor.

The Director is given a number of specific powers under the DPP Act. These include power to:

- prosecute by indictment and authorise others to sign indictments on his behalf;
- decline to proceed further in the prosecution of a person who has been committed for trial;
- take over proceedings commenced by another and either carry them on or discontinue them;
- discontinue proceedings being conducted by the DPP even if the informant wishes to proceed;
- grant indemnities to potential witnesses; and

- exercise any right of appeal that may be open to the Attorney-General or to the Director in his own right.

The Director has widely delegated his powers and the majority of operational decisions are made at regional level. However, current arrangements ensure that key decisions in major matters are made personally by the Director or the Associate Director.

---



[Return to the Annual Report Table of Contents](#)



[Return to the DPP Home Page](#)

---



 [Annual Report 1995-96](#)

 [Chapter 1 - Office of the DPP](#)

  [Organisation](#)

 [Head Office](#)

 [DPP Regional Offices](#)

 [Hobart and Darwin](#)

 [Senior Management](#)

---

 [Return to the Annual Report Table of Contents](#)

 [Return to the DPP Home Page](#)

---





## Organisation

The DPP has a Head Office in Canberra and regional offices in Sydney, Melbourne, Brisbane, Perth and Adelaide. There is also a sub-office of the Brisbane Office in Townsville.

At present the DPP has no office in Tasmania or the Northern Territory. In those places, Commonwealth prosecutions and related civil proceedings are conducted on behalf of the DPP by the Australian Government Solicitor pursuant to an arrangement under section 32 of the DPP Act.

### Head Office

Head Office provides policy and legal advice to the Director, controls and coordinates activities across Australia, liaises at national level with other agencies and provides administrative support to the Director. Head Office is also responsible for conducting prosecutions for Commonwealth offences in the ACT and for related criminal assets proceedings.

Head Office is made up of six branches: Litigation, Corporations, Criminal Assets, Policy, ACT Prosecutions and Resource Management.

The first three branches supervise the conduct of cases by the regional offices, provide input and assistance where it is needed and advise the Director in matters warranting his involvement. They also liaise with other agencies, provide advice on legal issues of general relevance, and provide input into the development of policy on matters within their areas of responsibility. The Corporations Branch also has carriage of corporations prosecutions in the ACT and the Criminal Assets Branch has the carriage of criminal assets work in the ACT.

The Policy Branch is responsible for assisting the Director develop and apply policies in relation to the DPP's prosecution functions. It is also responsible for developing and maintaining guidelines to assist DPP officers and for making recommendations to other agencies, particularly the Attorney-General's Department, in relation to Commonwealth criminal law and proposed changes to it.

The ACT Prosecutions Branch is responsible for conducting prosecutions for offences against Commonwealth law in the ACT.

The Resource Management Branch is responsible for the national coordination of budget and personnel policy, information technology, library support and public relations advice. It also provides administrative services to the Director and the Head Office branches.

### DPP Regional Offices

The regional offices are responsible for conducting prosecutions and civil recovery action.

Each office is divided into at least four branches: General Prosecutions, Corporate Prosecutions, Criminal Assets and Resource Management. Sydney has two additional General Prosecutions branches and Melbourne has one additional

General Prosecutions Branch.

The sub-office in Townsville is not divided into functional units.

## Hobart and Darwin

In Tasmania and the Northern Territory, prosecutions and criminal assets work is carried out by the Australian Government Solicitor as part of the general work of the office.

## Senior Management

A senior management chart follows.

## Senior Management Chart

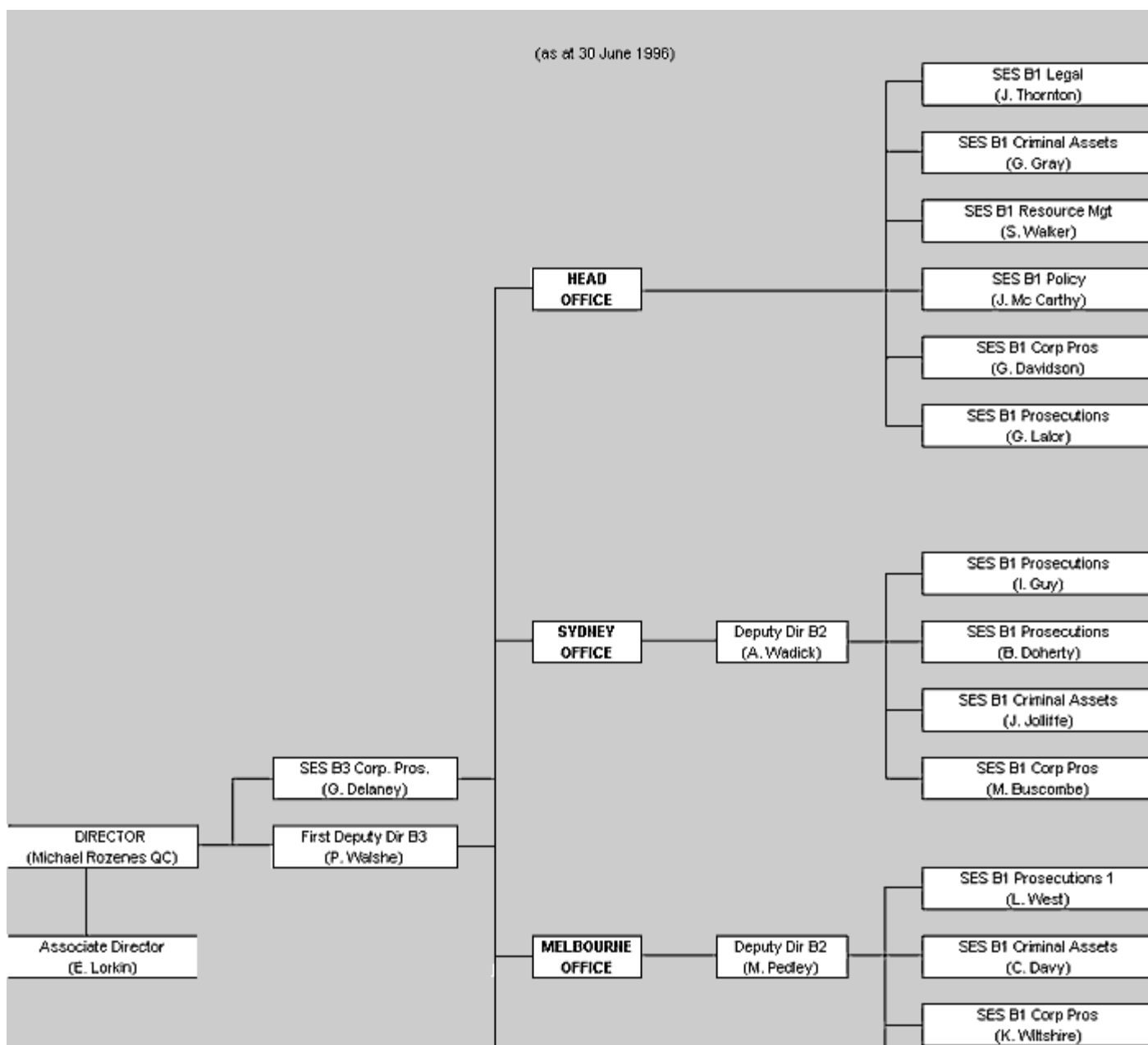

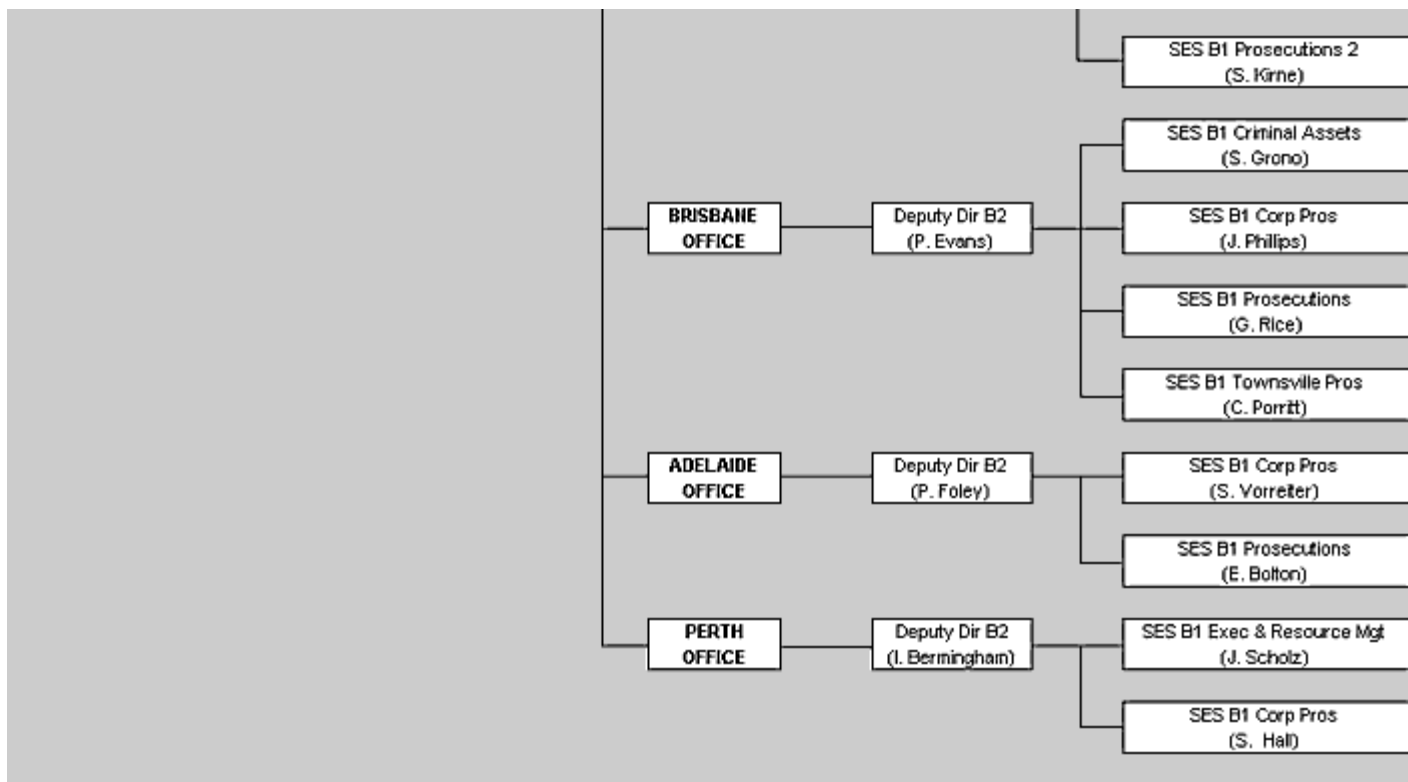

[Return to the Annual Report Table of Contents](#)



[Return to the DPP Home Page](#)



 [Annual Report 1995-96](#)

  [Chapter 2 - Exercise of Statutory Powers](#)

 [No Bill Applications](#)

 [Appeals](#)

 [Indemnities](#)

 [Taking Matters Over](#)

 [Ex-Officio Indictments](#)

 [Consent To Conspiracy Proceedings](#)

---

 [Return to the Annual Report Table of Contents](#)

 [Return to the DPP Home Page](#)

---



## Chapter 2

### Exercise of Statutory Powers

This chapter deals with the exercise of the statutory powers which have not been delegated beyond Head Office.

#### No Bill Applications

The Director has power under [Section 9\(7\) of the DPP Act](#) to decline to proceed in the prosecution of a person who has been committed for trial by a magistrate.

This power has only been partially delegated. Senior officers in the regional offices have power to reject a no bill application made at the court door if it clearly lacks merit. In any other case a no-bill application received from a defendant, and any proposal by a regional office not to file an indictment, must be referred for decision by the Director or the Associate Director.

In the past year there were 41 no bill applications received from defendants or their representatives. Of these, 18 were granted and 23 refused. A further 21 prosecutions were discontinued on the basis of a recommendation from a regional office without prior representations from the defendant. The total number of cases discontinued was 39 which is the same as for 1994-95. A breakdown of these statistics appears in table 1 at the end of this Chapter.

Under the Prosecution policy of the Commonwealth, the decision to prosecute requires that there be reasonable prospects of conviction and that the public interest requires a prosecution. Of the 39 matters discontinued prior to trial, the sufficiency of evidence was the main factor in 21 cases. In the remaining 18 cases, public interest factors were the main reason for discontinuing. Those factors included the defendant's health, circumstances surrounding the offence and general humanitarian grounds. A breakdown of these statistics appears in [table 2](#) at the end of this Chapter.



[Return to the Annual Report Table of Contents](#)



[Return to the DPP Home Page](#)



## Appeals

[Section 9\(7\) of the DPP Act](#) gives the Director the same rights of appeal in matters being conducted by the DPP as are available to the Attorney-General.

This and related provisions give the DPP power to appeal against an inadequate sentence, to seek review of a ruling by a magistrate on a point of law, and to appeal against a grant of bail.

The DPP has no power to seek review of a Jury verdict acquitting the defendant on the merits of the case. However, the DPP can seek review of points of law that arise at trial and can generally seek further review where an intermediate court has set aside a conviction.

The DPP follows a policy of restraint in these matters. The Office only appeals in cases where there is a clear public interest in seeking review of a decision.

All proposed appeals must be referred to Head Office for decision by the Director or the Associate Director unless the appeal period is about to expire. In that case a Deputy Director may file appeal papers and seek retrospective approval for the appeal.

Statistics on the number of appeals lodged by the DPP during the year appear in the tables at the end of this report.



[Return to the Annual Report Table of Contents](#)



[Return to the DPP Home Page](#)



## Indemnities

[Section 9\(6\) of the DPP Act](#) of the DPP Act empowers the Director to give an undertaking to a potential witness in Commonwealth proceedings that any evidence the person may give, and anything derived from that evidence, will not be used in evidence against the person other than in proceedings for perjury.

Section 9(6B) enables the Director to give a similar undertaking to a potential witness in State proceedings where there is a risk of the witness disclosing the commission of offences against Commonwealth law.

Section 9(6D) empowers the Director to give an undertaking to a person that they will not be prosecuted under Commonwealth law in respect of a specified offence or specified conduct. This is equivalent to a transactional indemnity.

In some cases the only way of proceeding against a serious offender is to call evidence from lesser participants in the criminal scheme. It is desirable that lesser offenders be prosecuted for their role before they are called as witnesses. However, that is not always possible. The only way of proceeding in some cases is by giving the witness an undertaking under section 9(6), 9(6B) or 9(6D).

In the past year the Director or the Associate Director signed a total of 47 undertakings under sections 9(6), 9(6B) and 9(6D). In some cases, indemnities were given to more than one witness. In total, indemnities were given in 19 prosecutions. A breakdown of the figures for 1995-96 appears in tables 3 and 4 at the end of this Chapter.

The Director also has power under section 30(5) of the *National Crime Authority Act 1984* to give an undertaking to a person who has been summonsed to appear before the NCA that any evidence they may give, and anything derived from that evidence, will not be used in a prosecution for an offence against Commonwealth law, other than perjury. Two undertakings were given in one matter in 1995-96.



[Return to the Annual Report Table of Contents](#)



[Return to the DPP Home Page](#)



## Taking Matters Over

Under [Section 9\(5\) of the DPP Act](#) the Director has power to take over a prosecution for a Commonwealth offence that has been instituted by another and either carry it on or bring it to an end. The power was not exercised during 1995-96.

---



[Return to the Annual Report Table of Contents](#)



[Return to the DPP Home Page](#)

---





## Ex-Officio Indictments

The Director has power under [Section 6\(2D\) of the DPP Act](#) to file an indictment against a person for charges in respect of which they have not been committed for trial. The power, which cannot be delegated, was exercised four times in 1995-96.

---



[Return to the Annual Report Table of Contents](#)



[Return to the DPP Home Page](#)

---



 [Annual Report 1995-96](#)

 [Chapter 2 - Exercise of Statutory Powers](#)

  [Consent To Conspiracy Proceedings](#)

 [Table 1: No bill matters](#)

 [Table 2: Reasons for discontinuing prior to trial](#)

 [Table 3: Indemnities - numbers](#)

 [Table 4: Indemnities - types of case](#)



[Return to the Annual Report Table of Contents](#)



[Return to the DPP Home Page](#)



Commonwealth **Annual Report**  
Director of Public Prosecutions **1995-96**

 [Annual Report 1995-96](#)

-   [Chapter 3 - General Prosecutions](#)
-  [Case Reports](#)



[Return to the Annual Report Table of Contents](#)





















[Return to the DPP Home Page](#)



 [Annual Report 1995-96](#)

 [Chapter 3 - General Prosecutions](#)

  [Case Reports](#)

-  [Spink and others](#)
-  [Prosecution of "Person C"](#)
-  [O'Donoghue](#)
-  [Prosecutions under the Aerodrome Flight Corridors Regulations](#)
-  [Keyes](#)
-  [Charlesworth](#)
-  [Tan](#)
-  [Medina](#)
-  [Operation Cryptic](#)
-  [Phan and Nguyen](#)
-  [McKendry](#)
-  [Teuma](#)
-  [Dreghorn and Newton](#)
-  [Youman](#)
-  [Tatow and Brown](#)
-  [Rossiter and Mackay](#)
-  [Hughes](#)
-  [Neilsen and Petterson](#)
-  [Gudgeon](#)
-  [Fermanian and Fermanian](#)
-  [Hill, Prince, Prince and Brodie](#)
-  [Carter, Liotta and Narayan](#)
-  [O'Farrall](#)
-  [Sampson](#)
-  [Operation Pyrites](#)
-  [Wan and Cheung](#)
-  [Cue Design Pty Ltd And Cue And Co Pty Ltd](#)
-  [Vales Wine Co, Von Berg & Curtis](#)
-  [South Australian Seedgrowers Co-Operative Limited](#)
-  [Operation Brogue](#)
-  [Rutu](#)



[Return to the Annual Report Table of Contents](#)



[Return to the DPP Home Page](#)



## Case Reports

### Spink and others

The defendants in this case were charged with conspiring to import 15 tonnes of cannabis resin worth approximately \$75 million. The resin originated in Pakistan and was shipped to international waters near New Caledonia and then transferred to an Australian boat and shipped into Hervey Bay, Queensland.

The organisers met the overseas suppliers in Europe in August 1993. They recruited others to purchase, fit out and sail the boats, take delivery of the cannabis resin, return to Australia and unload the drugs. One defendant was recruited to assist in unloading the boat upon its return to Hervey Bay. Three defendants were recruited by the overseas suppliers to crew the other boat.

In one of the AFP's biggest operations, it intercepted 80 000 telephone conversations between people involved in the conspiracy between June 1993 and August 1994. Most of the conversations were conducted in code which was broken by AFP investigators.

On 5 August 1994, the AFP intercepted the Australian boat in Hervey Bay. Some of the defendants were arrested in Australia and three were arrested in Papua New Guinea when the AFP intercepted the other boat. The three defendants arrested in Papua New Guinea were extradited to Australia. Most of those arrested entered pleas of guilty.

The boat that was intercepted in PNG was forfeited to the Commonwealth on 17 September 1995. It was sold for \$190 000 and \$117 102, being the net proceeds of sale, was paid into the Confiscated Assets Trust Fund.

The defendants who have been convicted received sentences ranging from 13 years imprisonment with a non-parole period of nine years to five years imprisonment with a non-parole period of two and a half years. Four sentences were significantly discounted because of assistance provided to the police.

### Prosecution of "Person C"

This case was the first prosecution in Australia for an offence under the *Crimes (Child Sex Tourism) Amendment Act 1994*. The defendant was given the pseudonym "Person C" by order of the court.

C was arrested on 30 August 1995 in Sydney on a charge of indecent assault under the NSW Crimes Act. A search of his premises located videos and documents which formed the basis for other charges under NSW law and for the Commonwealth offence.

The Commonwealth charge related to a home video depicting a young Asian girl posing undressed for C. The video had been taken in the Philippines and C admitted that he paid another person to film the child. C was charged with committing an act of indecency with a child outside Australia.

The Commonwealth legislation came into operation on 5 July 1994 and gives effect to Australia's obligations under the Convention on the Rights of the Child. It is designed to protect children at the national and international level from

sexual exploitation and abuse and applies to conduct committed by Australians both in and outside of Australia.

C was sentenced to a fixed term of imprisonment of two years as well as periods of imprisonment for several State offences.

### **O'Donoghue**

The defendant, who carried on a haulage business, had a practice of supplementing the taxed wages of his truck drivers with untaxed cash payments, or "funny money". He also dishonestly altered company accounting records so as to transfer, on paper, some income and tax deductions from three employees to himself. This incorrectly increased the amount of tax he was shown to have paid, putting him in a position to claim a tax refund he was not entitled to.

The AFP executed search warrants on the defendant's premises and found documents which disclosed the separate system of cash payments and the altered company records.

The defendant was committed for trial on charges under the Crimes Act. He sought a sentence indication but decided not to accept the sentence indicated. He later pleaded guilty one week before the trial date. The sentencing judge found that the conduct was inconsistent with genuine remorse. He accepted that the defendant would not have offended but for financial problems faced by his business but stated that business people are not entitled to resort to tax fraud to solve their liquidity problems.

The judge took into account 74 further offences against the *Income Tax Assessment Act 1936* of failing to pay group tax. He imposed a sentence of 12 months custody and made a reparation order for \$367 000, which covered both the fraud offences and the offences taken into account.

### **Prosecutions under the Aerodrome Flight Corridors Regulations**

The *Air Navigation (Aerodrome Flight Corridors) Regulations 1994* were one of a number of initiatives designed to reduce noise at Sydney Airport. They set out coordinates of flight corridors and were designed to confine planes to narrow flight paths in order to minimise the number of people affected by aircraft noise.

The regulations provided that a jet aircraft landing at or taking off from the airport must fly in the appropriate designated flight corridor and not deviate from it except in accordance with an instruction or approval from air traffic control. The maximum penalty, in the case of corporation, was a fine of \$25 000.

The DPP successfully prosecuted one airline for an offence concerning a Boeing 747 aircraft. The company was fined \$15 000. Consolidated Press Holdings Pty Ltd was prosecuted for a similar offence involving a McDonnell Douglas DC8-62, and was fined \$8 000.

The prosecutions raised difficult evidentiary problems, particularly in proving precisely where the relevant aircraft was at the relevant time. That turned on proving the accuracy of radar equipment and the methods used to plot aircraft relative to the corridors.

### **Keyes**

This case concerned a conspiracy to import heroin into Australia. The defendants tried to import heroin on three occasions.

The first importation occurred in 1990 when the defendant imported two and a half kilograms of high quality heroin from Thailand via the Cook Islands inside tins of pineapple. The second attempt concerned a venture whereby a Thai

national was to send five kilograms of heroin from Bangkok to the Papua New Guinea island of Dauru. The defendant was to collect it and bring it into Australia. This importation did not come to fruition as the Bangkok supplier was arrested.

On the third occasion the defendant planned to import approximately eight to ten kilograms of heroin by boat from Thailand. The defendant purchased a boat in England which he sailed to Spain. Whilst in Spain he was taken into custody in relation to unrelated local offences. Australia sought extradition in February 1993. Keyes was extradited from Spain in December 1995 after serving a jail term in relation to the Spanish offences.

Keyes pleaded guilty to the charges against him. He was sentenced to imprisonment for 15 years with a non-parole period of nine and a half years.

### **Charlesworth**

The defendant in this case was convicted on four counts of defrauding the Commonwealth Bank of approximately \$1 million between 1988 and 1991. The defendant, who was bankrupt, assumed the identity of her wealthy sister in order to obtain bank loans. She successfully obtained a personal loan, an overdraft facility and a company overdraft facility which she used to support the management of an interior design business.

The defendant also pleaded guilty to two counts under NSW law relating to a personal loan and Mastercard facility which she obtained from Westpac by representing herself to be another woman. She also pleaded guilty to one count of managing a corporation without leave while bankrupt and she had offences of making a false statement to obtain a passport in her sister's name and leaving Australia without permission from her trustee taken into account at sentence.

The defendant was sentenced to six years imprisonment with a non-parole period of four years and eight months.

### **Tan**

This case concerned the importation of 47 blocks of heroin with a gross weight of 18.6 kilograms. The heroin was concealed in a heat strapping machine which was sent from Malaysia to Australia. The heroin was about 80% pure and had a street value of about \$32 million.

The AFP arranged for the machine to be delivered under surveillance to the consignee. The police arrested one man at that location. They subsequently identified and arrested the defendant.

After a three month trial the defendant was convicted on one count of being knowingly concerned in the importation of a commercial quantity of heroin contrary to section 233B of the *Customs Act 1901* and one count of conspiring to traffic in a drug of dependence under Victorian law. He was sentenced to life imprisonment with a non-parole period of 18 years in respect of the Commonwealth charge and to 16 years imprisonment with a minimum of 12 years in respect of the State charge.

The defendant has appealed against conviction and sentence.

### **Medina**

In this case the defendant was convicted of an offence under State law of aiding or enabling another to supply cocaine. The prosecution was conducted by the DPP by agreement with the State DPP as it arose from an AFP operation involving a controlled delivery of drugs. The drugs were detected when a Columbian courier was apprehended in Sydney with more than one kilogram of cocaine disguised as coffee beans.

The defendant challenged his conviction arguing that the controlled delivery was unlawful and the evidence against him fell within the exclusionary principles outlined by the High Court in *Ridgeway*. Other grounds of appeal related to the use of a listening device and the role performed by the courier after he agreed to cooperate with the police.

The Court of Criminal Appeal rejected the appeal holding that the AFP conduct was proper and that it is legitimate for law enforcement officers to allow an enterprise to continue so as to identify and arrest other offenders. The High Court subsequently refused the defendant special leave to appeal.

### **Operation Cryptic**

This prosecution involved five people who imported 16 kilograms of heroin on board a container ship. The heroin was hidden in false compartments in the base of 44 decorated garden pots. The pots were part of a consignment of 364 garden pots. Customs officers in Melbourne detected the heroin when the pots were X-rayed.

The AFP allowed the defendants to collect the pots and kept them under surveillance. The defendants loaded all 364 pots onto two trucks which they then drove from the docks by a circuitous route. Three defendants were seen at various times in the rear of the first truck smashing pots to extract heroin. The AFP recovered the heroin from the second truck when it was well on its way to Sydney. They arrested all five defendants.

Three defendants pleaded guilty and received sentences from 14 years six months imprisonment with a minimum of term of ten years six months to seven years imprisonment with a minimum of five years.

Two defendants pleaded not guilty. One was convicted by the jury and sentenced to 13 years imprisonment with a minimum term of nine years. The other, whose role was to drive the truck which carried the pots of heroin, was acquitted. He claimed that he had been recruited as a driver and denied knowing that the pots contained heroin.

Two of the defendants have appealed against sentence and one has appealed against conviction.

### **Phan and Nguyen**

This case concerned a cheque laundering tax evasion scheme. The defendants ran a clothes manufacturing business over two years. During that time they lodged tax returns in which they failed to declare the proceeds of a large number of cheques they received as payment for work done. They cashed the cheques through a third party who paid the face value of the cheques less a five per cent commission. The amount of income not declared by the business for the two years was nearly \$2 million. The resultant tax avoided by the defendants was approximately \$230 000 each.

The defendants pleaded guilty to charges under the Crimes Act and were each sentenced to 30 months imprisonment to be released after serving 18 months. They appealed unsuccessfully against the sentences.

### **McKendry**

The defendant was a travel clerk with the Australian Army stationed at Melbourne. His duties involved arranging travel for army personnel and preparing documents for the payment of travel allowance. On 326 occasions he prepared false claims for fictitious travel, forged the signature of the approving officer and fraudulently obtained money for himself from the cash office. The total amount of the fraud was \$377 000.

The defendant pleaded guilty to one count of defrauding the Commonwealth and was sentenced to three years imprisonment, to be released after two years. He was ordered to pay reparation of \$332 000, being the amount of the fraud which had not been recovered. The defendant appealed unsuccessfully against his sentence.



## **Teuma**

The defendant in this matter was the Melbourne representative of a Maltese bank which was authorised to operate in Australia on a restricted basis. The method by which the bank accepted deposits in Australia enabled investments to be made in Malta in such a way that the principal and any interest income could be concealed from Australian authorities. Confidentiality was a major selling point for the bank and was emphasised in the bank's promotional literature.

The defendant was charged with structuring offences under section 31 of the *Financial Transaction Reports Act 1988* and with urging and encouraging the commission of offences against that provision. The defendant advised or assisted customers to make deposits by way of investment with the bank in such a way that the transactions did not exceed \$10 000, thereby avoiding the reporting requirements of the Financial Transaction Reports Act. He pleaded guilty in the Melbourne Magistrates' Court and was fined \$1 500 on each charge, a total of \$6 000.

The managers of the Queensland and NSW offices of the bank were also prosecuted for offences against the Financial Transaction Reports Act.

## **Dreghorn and Newton**

In this case the Commonwealth was defrauded of \$153 000 by the defendants who owned and operated a child care centre. The defendants claimed that more children attended the centre than actually did, thereby inflating the fee relief payments that were payable to them under the Child Care Fee Relief Scheme administered by the Department of Human Services and Health. The defendants used false daily attendance records and false receipts to support the fraud.

The defendants were convicted on charges under the Crimes Act. Dreghorn was sentenced to four years imprisonment with a minimum term of eighteen months and Newton was sentenced to four years imprisonment with a minimum term of twelve months.

## **Youman**

This prosecution related to damage caused to the historic shipwreck *Yongala* in January 1996 when the anchor of a fishing trawler was dropped on it and scraped some coral from the side of the wreck, possibly hastening its deterioration. The wreck is inside the Great Barrier Reef Marine Park. The master of the fishing trawler was fined \$300 for an offence against the Historic Shipwrecks Regulations of mooring in a protected zone without a permit and \$1 000 for an offence against the *Great Barrier Reef Marine Park Act 1975* of not having his fishing gear stowed whilst being in the Park. At sentence the magistrate commented that the penalty provisions in the Historic Shipwrecks Regulations are inadequate.

## **Tatow and Brown**

The defendant Tatow was an employee of the Department of Employment Education and Training who used the computer passwords of two other DEET employees to access records and establish false claims within the DEET computer system. This resulted in \$68 600 being paid to various bank accounts which had been opened by Brown, Tatow's fiance, using a forged birth certificate.

Evidence of computer experts showed that Tatow had the ability and the opportunity to complete the false records. Further evidence showed that he and Brown had a large amount of cash immediately after the offences had been committed. After an eight day trial both defendants were convicted of defrauding the Commonwealth.

Tatow, the DEET employee, was sentenced to three and a half years imprisonment with a non-parole period of twenty two months. Brown was sentenced to three years imprisonment with a minimum term of eighteen months. Orders were made for the forfeiture of a motor vehicle and a diamond ring which had been purchased with the proceeds of the crimes.

### **Rossiter and Mackay**

One of the defendants in this case was a real estate agent who purchased and sold property on the Gold Coast, making a profit of \$204 000 using a false name. The other defendant was his accountant. The accountant arranged for the profit to be disclosed in the income tax return of another client, who had tax losses, in such a way that the other client was not aware that the profit had been declared in his return. The arrangement was covered by a round robin transaction to make it look as though the arrangement was legitimate. The accountant received \$16 000 for arranging the transactions.

The matter was investigated by ATO and AFP. The defendants pleaded guilty to charges under the Crimes Act.

The real estate agent was sentenced to 18 months imprisonment to be released forthwith on a good behaviour bond. The DPP appealed against the sentence. The Queensland Court of Appeal upheld the appeal and ordered that the defendant serve three months imprisonment.

The accountant was sentenced to three years imprisonment to be released after six months. He was also ordered to pay a pecuniary penalty under the Proceeds of Crime Act in the sum of \$16 000, being the amount he was paid for his services.

### **Hughes**

In August 1994 the defendant telephoned the owner of a security operations business and said he wanted weapons for a revolution in Africa. The businessman alerted the Queensland Police who arranged for future telephone calls to be recorded.

Over the ensuing months the defendant revealed that he was negotiating on behalf of dissidents in the Republic of Cameroon and that the weapons were required for a proposed civil war. The defendant said he wanted \$1.5 million worth of weapons including machine guns, rifles, pistols, ammunition and remote control explosives. He discussed methods of concealing the weapons in bags of rice imported into Cameroon.

In February 1996 the defendant pleaded guilty in the Brisbane District Court to doing acts preparatory to engaging in hostile activity in a foreign State, an offence against the *Crimes (Foreign Incursions and Recruitment) Act 1978*. He was sentenced to two and a half years imprisonment with a minimum term of eight months. In May 1996 the Court of Appeal refused an application for leave to appeal against sentence.

The court also ordered that documents, which included weapons catalogues and contact numbers for arms dealers, be forfeited under section 19 of the Proceeds of Crime Act on the basis that they were tainted property. The forfeiture order meant that the documents could be destroyed instead of being returned to the defendant.

### **Neilsen and Petterson**

One of the defendants operated a nursing home. Between 1986 and 1991 he submitted claim forms to the Department of Human Services and Health which he knew contained false particulars. He claimed for the costs of repairs and maintenance which were not carried out, for accounting fees that had not been incurred and for falsified laundry costs for residents. The defendant also claimed for salaries paid to clerical staff as if they were nursing costs.

The second defendant was a consultant who previously worked for the Department in the nursing home funding section. He helped the first defendant to prepare the false claim forms.

As a result of the fraud, the nursing home received excess funding of \$75 000. After a two week trial both defendants were convicted of defrauding the Commonwealth and were sentenced to three years imprisonment with a minimum term of fifteen months.

### **Gudgeon**

This case involved the importation of 192 kilograms of cannabis into Australia in a shipping container from Thailand. The defendant was one of the principals and was the person who instigated the importation. He was convicted on one count of importing a commercial quantity of cannabis after a sixteen day trial at which he was not legally represented. He was sentenced to fifteen years imprisonment with a non-parole period of seven and a half years.

The defendant appealed against conviction and sentence. The appeal against conviction was based on the principles established by the High Court cases of *Dietrich and Ridgeway*. The appeals were dismissed.

The Court of Appeal distinguished *Ridgeway* on the basis that there was substantial evidence of the defendant's involvement in the conspiracy apart from any police action in the importation. The court decided that the defendant's conduct was not the product of illegal activity by police. On the *Dietrich* issue, the Court found that in the face of the overwhelming prosecution evidence against the defendant, he was not deprived of a chance of acquittal which was fairly open to him.

### **Fermanian and Fermanian**

The defendants were husband and wife. The wife was charged with defrauding the Commonwealth and the husband with being knowingly concerned in her offence. The wife collected a pension from the Department of Social Security in the name of her deceased step-father over a ten-year period. The amount involved was over \$75 000.

The wife pleaded guilty to the charge against her.

It was alleged that the husband assisted the wife by completing banking and departmental forms. He denied involvement and said his wife's brother completed the forms. The prosecution called evidence from the wife's brother and from handwriting and fingerprint experts. The husband was convicted after a trial.

The wife was sentenced to three years imprisonment with release after nine months and was ordered to pay a pecuniary penalty order in respect of the outstanding debt. The husband was sentenced to four years imprisonment with a non-parole period of two years.

### **Hill, Prince, Prince and Brodie**

In this matter the defendants were charged with being knowingly concerned in the exportation of wildlife contrary to section 21 of the *Wildlife Protection (Regulation of Exports and Imports) Act 1982*. In May 1993 one of the defendants flew to New Zealand with a dozen cages of galahs and Major Mitchell cockatoos. In September 1993 he flew to New Zealand taking at least ten Gang Gang cockatoos and twenty one Major Mitchell cockatoos. On this occasion the aircraft and the birds were intercepted by New Zealand authorities. The pilot assisted the authorities and named others involved in the scheme.

The defendants were convicted. Three were sentenced to terms of imprisonment ranging from twenty one to eighteen

months imprisonment with release periods ranging from eight to four months. One was released without passing sentence.

### **Carter, Liotta and Narayan**

These defendants were charged with defrauding the Commonwealth and with being knowingly concerned in the fraud. In 1993 a company, of which one of the defendants was the managing director, successfully applied for an export market development grant of \$205 000 in respect of fees paid for overseas market research. For the expenditure to qualify for a grant the payments had to be made to researchers who were at arms length from the company.

The principal defendant used back-dated consultancy agreements to make it appear that investor/working partners were arms length consultants. In one case he made it appear that there was a consultancy arrangement when no business relationship ever existed. The other defendants helped the principal defendant to falsify receipts, invoices and other documents to support the scheme.

After a twenty-five day trial the principal offender was convicted and sentenced to five years with a non-parole period of two and half years. The other defendants were sentenced to two years with release, respectively, after five months and six months.

### **O'Farrall**

This case was the largest known misappropriation case in the history of Australia Post. The defendant was a mail delivery contractor working from the Rockingham branch of Australia Post. His duties involved delivering mail to various localities within the area of Rockingham. He was charged with destroying, misappropriating and opening mail and hindering the carriage of mail over a period in excess of seven months.

In November 1994 a search uncovered a large quantity of mail hidden in the defendant's van. A subsequent search of his home uncovered over 2 000 items of shredded mail, close to 13 000 items of undelivered mail, and the remains of an unknown quantity of mail that he had opened. There was evidence that the defendant misappropriated 290 articles of mail. When he was interviewed the defendant admitted that he had failed to deliver the mail in accordance with his instructions. He said that the job was becoming too much for him.

The defendant pleaded guilty to four charges. He was convicted after trial on two other charges. He was sentenced to imprisonment for 18 months with a minimum of nine months and was ordered to make reparation to Australia Post to cover the cost of re-directing the mail.

### **Sampson**

The defendant in this case was employed by the Health Insurance Commission for over 11 years. At the time of the alleged offences he was the Southern Regional Manager of the HIC responsible for HIC branches in the southern half of Perth and the southern part of WA. Prior to this he was an investigations officer with HIC stationed in Queensland for two years and before that he was a detective in the NSW Police.

The defendant, together with another person who had been an HIC fraud investigator, submitted false claims for health benefits under the Medicare system. He made a total of 95 fraudulent claims in 15 different names involving 476 alleged consultations. The total value of claims was \$56 000 of which \$46 000 was paid by HIC.

The claims were made for psychiatric services in the names of people who the defendant and his co-offender had identified from the newspapers to be serving prisoners. By reason of his previous employment, the defendant was aware of HIC's fraud detection techniques and took action to avoid them.

The defendant also misused his position to obtain genuine medical receipts for psychiatric service. He copied them and amended the details for use in the bogus claims. He also used an HIC stamp to enable cheques drawn in the names of prisoners to be deposited into bank accounts that he controlled.

The defendant was convicted of defrauding the Commonwealth contrary to section 29D of the Crimes Act. He was sentenced to 30 months imprisonment to be released after serving 15 months on entering into a recognisance for \$10 000 to be of good behaviour for the balance. An order was made under the Proceeds of Crime Act that he forfeit his share of the proceeds, namely \$23 000. The sentence was reduced by six months for promised co-operation pursuant to section 21E of the Crimes Act.

## **Operation Pyrites**

As a result of a National Crime Authority investigation, six men were charged with conspiring to defraud the Commonwealth and conspiring to structure cash deposits so as to avoid the reporting requirements of the Financial Transactions Reports Act. The scheme, devised by one of the accused who was an accountant, involved laundering money on which tax should have been paid by the purported purchase and sale of gold mining and exploration leases.

The conspirators established a gold mining syndicate. They then deposited money into the bank account of a company to enable the company to purport to buy the leases from them. The defendants deposited almost \$1 million into the company's bank account in amounts of less than \$10 000 at different branches of the same bank and in false names. The company then purported to purchase the leases from the syndicate and paid the money to the syndicate which then distributed the money to the defendants. The defendants thus received back their own money in circumstances where it appeared, on the surface, that they were able to claim that it was exempt from income tax under provisions dealing with income from gold mining. The defendants evaded more than \$460 000 in income tax.

Five defendants were convicted. The penalties ranged from imprisonment for three years six months to a fine of \$30 000. One defendant was acquitted. The ATO recovered more than \$1 million in tax and penalties.

## **Wan and Cheung**

These defendants were charged with being knowingly concerned in the importation of heroin and having possession of heroin following the importation of 32 kilograms of heroin by three crewmen of a Chinese ship.

One of the defendants took possession of the heroin from the crewmen, in company with another person who had travelled to Australia from Hong Kong. The two men took the heroin to Perth. Fifteen kilograms of heroin went to Sydney, where the AFP arrested two men.

The second defendant, a resident of Canada, flew to Perth after the importation and took possession of the remaining heroin. He gave nine kilograms of the heroin to two other men, who were also arrested by the AFP

The defendants and one other person were arrested by the AFP in possession of the remaining heroin. All three were charged with drug offences. However, the third person escaped from custody on the morning that his preliminary hearing was due to commence. His whereabouts are unknown.

One defendant pleaded guilty to both charges shortly prior to trial. The other pleaded guilty to the count of possession but defended the knowingly concerned charge. He was convicted at trial.

The defendants were sentenced respectively to 24 years six months imprisonment with a non-parole period of 16 years and 22 years six months imprisonment with a non-parole period of 13 years. The Chinese crewmen received substantial prison terms as did the others apprehended in the case.

## **Cue Design Pty Ltd And Cue And Co Pty Ltd**

These companies were jointly charged with 30 breaches of section 53(e) of the *Trade Practices Act 1974*.

One company designed and manufactured women's apparel and the other sold them. They organised for garments to be displayed for sale at various Cue stores throughout Australia in December 1994. The garments all bore tags on which a higher price was struck out and a lower price written in below it. The manner in which the tags were marked would have led a reasonable person to believe that each garment had previously been offered for sale at the higher price marked on the tag and was now being offered for sale at the lower price. All the representations were misleading in that the various garments had never been offered for sale at the higher price.

The judge viewed the conduct by the defendants as serious breaches of the TPA noting that it preyed upon the gullibility of the public. The companies were each ordered to pay a fine of \$37 500.

## **Vales Wine Co, Von Berg & Curtis**

The company, which ran a winery in South Australia's McLaren Vale district, was charged under the Trade Practices Act with 11 counts of false representation. Two former directors of the company were charged with aiding and abetting the company.

It was alleged that the company represented that blended wines were of a particular vintage or variety when they did not contain a high enough percentage of wine of that kind to allow the blend to be described in that way. One of the company's former wine makers was given an indemnity against prosecution and became a principal witness in the case.

The company was placed in liquidation prior to the trial commencing and was not represented at the trial. Both former directors pleaded not guilty

Following a five week trial the Federal Court found the company guilty on four counts and not guilty on seven and found the directors each guilty on one count and not guilty on three. The defendants have not yet been sentenced. Both former directors have appealed against conviction.

## **South Australian Seedgrowers Co-Operative Limited**

This defendant was charged with six offences of applying a false trade description to export goods contrary to section 15 of the *Export Control Act 1982*. The prosecution arose out of the export of lucerne seed to Morocco. The approximate weight of the consignment was 21 200 kilograms and the value of the consignment was US\$45 000.

The goods were described in various ways in different notices, certificates, tags and on the sacks in which they were exported. However, all descriptions gave the impression that the lucerne was of cultivar, or species, Moapa. The prosecution argued that the descriptions were false because the consignment did not contain lucerne seed that was of the cultivar Moapa but was a blend of various cultivars of South Australian lucerne seeds none of which included the cultivar Moapa.

The defendant admitted that the lucerne seeds were not of the cultivar Moapa but argued that the descriptions were not false because the seed was uncertified seed and the importers knew that it was not Moapa. The defendant argued that it was necessary to describe the seed as Moapa in order to comply with import restrictions in Morocco and with the letter of credit that was provided as payment of the consignment. The defendant also argued that the term "Moapa" was synonymous in Morocco with lucerne seed that was winter-active and that the seeds it supplied were predominantly winter-active.

The court did not accept the defendant's explanation, particularly having regard to evidence that other seed producers in South Australia had declined invitations to export lucerne described as Moapa to Morocco and had complained to the Department of Primary Industries that the defendant was doing so. The Department had approached the defendant prior to the export of the subject consignment warning that it may be in breach of the Trade Practices Act to describe the seeds as Moapa.

The defendant was convicted and fined \$14 400.

## **Operation Brogue**

This case concerned the captain and seven man crew of a Thai fishing vessel, Bahari 314, which arrived in Darwin Harbour in July 1994. Shortly after it moored a bag containing 40 kilograms of heroin was found floating in the harbour adjacent to the boat. A week later two further bags containing 80 kilograms of heroin were found attached to a weight on the sea bed in the vicinity of the boat. The seizure of the heroin is the largest in Australia.

The captain and two of the crew pleaded guilty to importing heroin and were sentenced to life imprisonment. The remaining crew members, who said that their families were threatened with death if they did not crew the boat, were acquitted at the trial.

## **Rutu**

This defendant was an Indonesian who landed six Turkish nationals at Ashmore and Cartier Island. He attempted to leave them there but was prevented from doing so by staff of the Australian Nature Conservation Agency who were on a boat moored at the Island.

The Island is not part of Australia for the purposes of the *Migration Act 1958* and the defendant could not be charged with a substantive offence under that Act. He was charged with attempting to bring foreign nationals to Australia contrary to section 233 of the Migration Act.

The defendant was convicted after a three day hearing. He was sentenced to ten weeks in jail, which was in addition to 12 weeks that he had already spent in custody. The court noted that if the defendant had not spent time in custody, it would have sentenced him to six months imprisonment.



[Return to the Annual Report Table of Contents](#)



[Return to the DPP Home Page](#)

---



Commonwealth **Annual Report**  
Director of Public Prosecutions **1995-96**

 [Annual Report 1995-96](#)

  [Chapter 4 - Corporate Prosecutions](#)

 [Case Reports](#)



[Return to the Annual Report Table of Contents](#)



[Return to the DPP Home Page](#)





 [Annual Report 1995-96](#)

 [Chapter 4 - Corporate Prosecutions](#)

  [Case Reports](#)

-  [Lord and Riordan](#)
-  [Carter, Blaxland and Vickery](#)
-  [Hodge](#)
-  [Towey](#)
-  [Donlon, McLennan and Mitry](#)
-  [Yuill](#)
-  [Williams](#)
-  [Casey and Robertson](#)
-  [Laurance, Searson and McHugh](#)
-  [Whittal](#)
-  [Hyland](#)
-  [Bond](#)
-  [Miller, Rose and Murphy](#)
-  [Bibby and Scott-Murphy](#)
-  [Lill, Bibby, Welch and Lawson](#)
-  [Fuller, Cummings and Johnson](#)
-  [Sivandran](#)
-  [Abbott, Fitzsimmons, Reid and Kovess](#)
-  [Hopwood and Byrnes](#)
-  [Crowl](#)





[Return to the Annual Report Table of Contents](#)



[Return to the DPP Home Page](#)



 [Annual Report 1995-96](#)

  [Chapter 5 - Criminal Assets](#)

 [Practice](#)

 [Management](#)

 [Confiscated Assets Trust Fund](#)

 [Superannuation Orders](#)

 [Case Reports](#)

---

 [Return to the Annual Report Table of Contents](#)

 [Return to the DPP Home Page](#)

---



 [Annual Report 1995-96](#)

 [Chapter 5 - Criminal Assets](#)

  [Practice](#)

 [Proceeds of Crime Act](#)

 [Customs Act](#)

 [Civil Remedies](#)

---

 [Return to the Annual Report Table of Contents](#)

 [Return to the DPP Home Page](#)

---



## Practice

The DPP does not take recovery action in every case where a person has obtained money as a result of a Commonwealth offence. In many cases, there is nothing the DPP can usefully add to the normal processes of Commonwealth debt recovery. In other cases there is no money left to recover.

The factors that the DPP looks at in deciding whether to take action in a particular case include whether there is a basis for recovery action if the DPP does not get involved, the size of the debt, whether the offender holds assets offshore or in a false name, whether the offender appears likely to resist recovery action, and whether there is need to coordinate recovery action with the criminal proceedings.

The DPP has three main avenues open to pursue the proceeds of Commonwealth crime. They are:

### Proceeds of Crime Act

[The PoC Act](#) provides a scheme to trace, freeze and confiscate criminal assets. The Act is conviction based, which means that no final orders can be made unless a person has been convicted of an indictable offence against Commonwealth law. However, there are provisions which enable courts to make restraining orders to ensure that property is not dissipated while the criminal proceedings run their course.

There are also provisions in the PoC Act which enable the courts to look behind the corporate veil when deciding whether to make restraining orders or final orders under the Act. The courts are entitled to look at whether the defendant has effective control over property even if he or she has no legal title to it.

The PoC Act applies to all indictable offences against Commonwealth law, although it is used mainly in relation to drug offences and serious fraud against the Commonwealth.

### Customs Act

Division 3 of Part XIII of the Customs Act contains a scheme which is similar to that under the PoC Act. However, the scheme applies only to drug offences and it is not conviction based.

The Customs Act provisions are used less frequently than the PoC Act, and generally only when there are no Commonwealth charges or there is some other reason why action cannot be taken under the PoC Act.

### Civil Remedies

The DPP is given a civil remedies function under sections 6(1)(fa) and 6(1)(h) of the DPP Act. The function is to take, or coordinate or supervise the taking of, civil remedies in matters connected with an actual or proposed prosecution.

The function does not involve any new powers of recovery. What it does is enable the DPP to enforce, or coordinate the

enforcement of, traditional civil remedies where the money at stake represents the proceeds of crime.

The civil remedies function is limited in that it can only be exercised to recover unpaid taxes and in matters or classes of matter that have been specified in an instrument signed by the Attorney-General. However, on 23 October 1995 the then Attorney-General signed an instrument which gives the DPP power to exercise the civil remedies function in any matter which gives rise to a civil liability towards the Commonwealth or an authority of the Commonwealth, provided that the matter is connected to an actual or proposed prosecution.

---



[Return to the Annual Report Table of Contents](#)



[Return to the DPP Home Page](#)

---



## Management

There is a Criminal Assets branch in each DPP regional office.

There is also a Criminal Assets Branch in Head Office which coordinates the work in this area. The Head Office branch also conducts case work in the ACT and coordinates the activities of the DPP in relation to extradition and mutual assistance.

There are no Criminal Assets branches in the Australian Government Solicitor's offices in Hobart and Darwin. In those places, criminal assets work is carried out as part of the general work of the office, with support from an appropriate regional office of the DPP when special expertise is needed.

It is important to maintain a Criminal Assets branch in each DPP Office. The work in this area is specialised and difficult and the expertise would be lost if there were no specialist branches.

The DPP maintains a computerised Criminal Assets Recording System to keep track of cases in the criminal assets area. CARS has proven invaluable for managing work in the Criminal Assets branches and for maintaining accurate records of restraining orders and when they need to be renewed.

The CARS system is cross-referenced with the records maintained by the prosecutions branches, and provides a means of checking to ensure that all cases where there is a potential for recovery action are reviewed by the Criminal Assets branches.



[Return to the Annual Report Table of Contents](#)



[Return to the DPP Home Page](#)



## Confiscated Assets Trust Fund

All money recovered under the PoC Act and Division 3 of Part XIII of the Customs Act is paid into the Criminal Assets Trust Fund. That fund is administered by the Insolvency and Trustee Service Australia.

As the law currently stands, money paid into the fund is used to finance law enforcement projects selected by the Attorney-General and drug rehabilitation programs selected by the Minister for Health.

Details of grants made to law enforcement agencies in the most recent funding round are set out in the table at the end of this Chapter.



[Return to the Annual Report Table of Contents](#)



[Return to the DPP Home Page](#)



## Superannuation Orders

The Criminal Assets branches also conduct proceedings under the *Crimes (Superannuation Benefits) Act 1989* and Part VA of the *Australian Federal Police Act 1979*. Under the *Crimes (Superannuation Benefits) Act* a Commonwealth employee who has been convicted of a corruption offence, as defined in that Act, and has been sentenced to more than 12 months imprisonment, can lose his or her government-funded superannuation benefits. There are similar provisions in the AFP Act, although a member of the AFP who has been found guilty of some types of disciplinary offence can also be deprived of superannuation.

The mechanism involves the Attorney-General issuing in authorisation to the DPP to apply for a superannuation order. The court that hears the application must make an order if it is satisfied that the preconditions for doing so have been met. The effect of a superannuation order is that the defendant loses all rights to employer-paid benefits under the superannuation scheme, although the defendant is entitled to recover his or her own contributions plus interest.

The DPP obtained five superannuation orders in 1995-96.



[Return to the Annual Report Table of Contents](#)



[Return to the DPP Home Page](#)





 [Annual Report 1995-96](#)

 [Chapter 5 - Criminal Assets](#)

  [Case Reports](#)

 [McCauley](#)

 [Cornwell](#)

 [Etri](#)

 [McKendry](#)

 [Cooper](#)

 [Kirkby](#)

 [Mansted](#)

 [Rice](#)

 [Operation Triton](#)

 [Ramdhun](#)

 [Table 1: Confiscated Assets Trust Fund: 1995 funding round](#)



[Return to the Annual Report Table of Contents](#)



[Return to the DPP Home Page](#)

---



## Case Reports

The Criminal Assets branches are involved in most major drug and fraud cases prosecuted by the DPP. Few of those cases do not have a financial aspect and at least a potential for recovery action. Reports on some of those cases appear in Chapter 3. Reports on some of the other cases conducted by the Criminal Assets branches appear below.

### McCauley

In 1994 Bruce McCauley was convicted of narcotics offences against the Customs Act. Assets recovery action has continued since then. The case has led to lengthy litigation in a number of jurisdictions.

One area of litigation involves action in the Family Court under section 79A of the *Family Law Act 1974* seeking to set aside a property settlement entered between McCauley and his former wife in 1990 on the basis that it was a device designed to place assets beyond the reach of the Australian Taxation Office. The DPP is acting as solicitor for ATO exercising the civil remedies function.

The case for ATO relies, in part, on documents that were obtained by means of production orders under the PoC Act and that are still held by the AFP. The DPP issued a subpoena to the AFP seeking access to those documents. The former wife responded by arguing that the subpoena was invalid because it would be improper for the DPP to use information obtained by the exercise of compulsory powers under the PoC Act to pursue civil recovery. The case raises serious issues about what can be done with information obtained under the PoC Act and has major implications for the future conduct of the DPP's civil remedies practices.

On 7 June 1995 a single judge of the Family Court found in favour of the ATO. He found that there was no impropriety in the use which the DPP proposes to make of the relevant documents. It is likely that the former wife will appeal against that decision.

The proceedings before the Family Court also led to proceedings before the Federal Court because section 58(3) of the *Bankruptcy Act 1966* provides that, when a person has become bankrupt, no creditor can enforce a remedy in respect of a provable debt or commence or continue legal proceedings in respect of a provable debt except with leave from the Federal Court. The former wife argued that the Family Law proceedings fell within section 58(3). The Family Court stayed the proceedings until the matter could be considered by the Federal Court.

On 14 December 1995, a single judge of the Federal Court ruled that the case probably did not fall within section 58(3) but that, even if it did, leave should be given to continue the Family Court proceedings. The purpose of section 58(3) is to protect the bankrupt and the bankrupt's estate. The present proceedings are being brought for the purpose of increasing the amount of money available to McCauley's estate. The former wife appealed to the Full Federal Court. The appeal has been heard and a decision is expected shortly.

Argument on the main issue in the case, which is whether the 1990 settlement was fraudulent, cannot proceed until all appeals on preliminary issues have been resolved.

A separate limb of the case involves \$1.9 million that was found in a bank account in Vanuatu in the name of a

company controlled by McCauley. That money was subsequently transferred to Hong Kong and is currently held in Hong Kong pursuant to Australian restraining orders that have been registered in Hong Kong.

The money in Hong Kong has been forfeited to the Commonwealth by operation of section 30 of the PoC Act. However, two Australian companies have brought proceedings under section 31 of the PoC Act seeking to have the money transferred to them on the basis that they are the true owners of the money and that it is not the proceeds of crime.

The companies had previously brought proceedings under section 48(3) of the PoC Act to attempt to avoid the operation of section 30. Those proceedings failed. The DPP argued that, as a matter of construction of section 31, the result was that the companies had exhausted their rights under the PoC Act. The DPP lost on that issue and was refused leave to appeal.

The companies have been given leave to pursue their claim under section 31. The next step is for them to file further evidence to support their claim to the money after which the matter will be listed for hearing.

## **Cornwell**

Bruce Cornwell was convicted of narcotic offences in 1989 and was ordered to pay a pecuniary penalty under section 243B of the Customs Act. In 1991 he went bankrupt. The Commonwealth lodged a proof of debt in the sum of \$8.7 million, being the pecuniary penalty plus interest and costs. Since then the DPP has been involved in assisting Cornwell's trustee in bankruptcy to identify property belonging to Cornwell.

Part of Cornwell's assets consisted of money held in a bank account in Switzerland. On 8 February 1990 the Swiss authorities obtained a confiscation order in the Zurich District Court on the basis that the money represented the proceeds of crime. Upon confiscation, the money became the property of the Swiss authorities. However, in accordance with mutual assistance arrangements between Switzerland and Australia, the Swiss authorities decided to share the proceeds with Australia. In May 1996 the sum of \$1.1 million was transferred to Australia. That money was paid into the CAT Fund.

## **Etri**

Mohammed and Abdul Etri were convicted of offences against section 15(1) of the Financial Transaction Reports Act of taking more than \$15 000 in cash from Australia without filing a report under that Act.

The defendants attempted to travel to Lebanon from Sydney Airport. A baggage search by Customs officers discovered \$120 000 in \$100 dollar notes hidden in Weetbix boxes in each of the defendants' hold luggage. The defendant's claimed that the money was the proceeds of market gardening in Australia.

The defendants pleaded guilty to the criminal charges and were released on good behaviour bonds. The real issue in the case was what should happen to the money.

The DPP applied for forfeiture orders under section 14 of the Proceeds of Crime Act on the basis that the money was tainted in that it was property used in the commission of the offences against the Financial Transactions Reports Act. Under section 14, the court has a discretion about how much of the relevant property should be forfeited. In a case of this kind, the court will normally look at the source of the money, the reason why it was being taken from Australia and whether forfeiture would cause hardship.

At first instance, the magistrate decided that both defendants should lose the full \$120 000. On appeal, the District Court confirmed the forfeiture order in respect of Abdul Etri but varied the forfeiture order in respect of Mohammed Etri. The court decided that \$82 000 should be excluded from the forfeiture to enable Mohammed Etri to pay that sum to the

Australian Taxation Office in payment of outstanding income tax.

The defendants have sought a stay of the forfeiture orders to allow them time to appeal further.

## **McKendry**

In this matter an army officer defrauded the Commonwealth of approximately \$325 000. McKendry purchased several vehicles in the names of others with funds derived from the offences. In particular, he purchased a Ford Capri for his defacto.

McKendry was convicted of offences under the Crimes Act and the DPP sought a forfeiture order in respect of the vehicles and other property. McKendry did not oppose the order, but his defacto opposed forfeiture of the Ford Capri.

The defacto claimed that she provided consideration for the car, in that she agreed to forego a claim to future maintenance, that she was not aware of the source of the monies, and that she would suffer hardship if the vehicle was taken from her. The County Court of Victoria ordered that the car be forfeited on the basis that, as the evidence stood, the court could not be satisfied that the defacto had no suspicion as to the source of the money. The court found that the defacto needed to show more to establish hardship than that she would suffer inconvenience if she lost the car. However, the court accepted that the defacto had provided consideration for the car.

The DPP argued that title to the car could not pass to the de facto because the car was bought with stolen money and, by the doctrine of equitable tracing, it remained the property of the Commonwealth. The County Court judgment did not resolve that issue.

The de facto has appealed to the Supreme Court of Victoria. The decision is likely to clarify a number of issues and should help to establish what limits apply to prevent a person who has stolen money from putting it beyond the reach of the owner simply by channelling it to their friends and relatives.

## **Cooper**

This defendant pleaded guilty to offences against section 76E of the Crimes Act and section 408C of the Criminal Code of Queensland involving the unlawful insertion, alteration, and misappropriation of data in computers owned by third parties. The defendant accessed computers in some large institutions in Australia and the USA.

An expert examination of the files on the defendant's computer showed programs which enabled the defendant to access remote computer systems and capture files and information such as user ID's and passwords. He was also able to insert, alter, and delete data in some remote computer systems and then hide his presence in those compromised systems.

At sentence, the prosecutor applied for a forfeiture order under section 19 of the PoC Act in respect of the computer equipment used to commit the offences. The court found that the equipment was tainted property and ordered that it be forfeited to the Commonwealth.

The AFP subsequently applied to the Attorney-General for a direction under section 20(3A) of the PoC Act that the equipment be transferred to the AFP to be used for operational purposes. The Attorney-General gave that direction.

## **Kirkby**

Kirkby was a director of a company which failed to remit group tax deducted from the wages of its employees. Kirkby was prosecuted under section 8Y of the *Taxation Administration Act 1953*. The company has been wound up. The DPP told the defendant that it would seek a reparation order at sentence. That led to negotiations which resulted in the

defendant entering into an agreement with ATO to repay that debt. As at 30 June 1996, the defendant had paid \$86 000 which had been credited towards the group tax owed by his company.

## **Mansted**

In this case a plane was seized under section 203 of the Customs Act after being used in the importation of cannabis from Papua New Guinea. The defendants did not seek return of the plane, and it was condemned as forfeited to the Commonwealth.

The plane was sold for \$39 000. The net proceeds from the sale, after payment of storage fees, commission and administration fees was \$21 104. That money has been paid into the CAT Fund.

The pilot of the plane and another person have been convicted of offences against the Customs Act and sentenced to seven years imprisonment with a non-parole period of two and a half years.

## **Rice**

This defendant was charged with two offences against section 29A of the Crimes Act. It was alleged that she improperly obtained \$182 000 in social security benefits over a 20 year period by claiming benefits in three different names. The defendant was 65 years old by the time the fraud came to light. She pleaded guilty to the charges against her.

The DPP obtained a restraining order under the PoC Act over the defendant's home and \$7 000 that was found in bank accounts that she had opened in the names she used to claim benefits. The matter was resolved when the defendant agreed to sell her house and use the money to repay the Department of Social Security. The DPP consented to a lifting of the restraining order to allow that to occur. DSS eventually managed to recover a substantial part of the debt.

## **Operation Triton**

This case arose when three people were arrested at Mt Isa and charged with conspiring to import 150 kilograms of cannabis from Papua New Guinea. The defendants were on their way to PNG in a small plane that they had chartered for the trip.

The criminal assets aspect related to a second plane that was owned by one of the defendants and which was normally used in a business of operating a flying school. It is alleged that the conspirators originally planned to use that plane for the importation. They took a number of steps to prepare the plane for the trip, including arranging insurance cover, ordering crystals for the radio to make it compatible with PNG frequencies, and arranging for their pilot to get endorsed on the plane. The pilot had undergone 1.4 hours of training when the plan changed.

It appears that the conspirators decided to change planes after they received a letter from the Civil Aviation Authority advising that their plane was overdue for weighing. This caused some panic, presumably because the conspirators needed to be able to fly to PNG at short notice.

The DPP argued that the plane was tainted property in respect of the conspiracy to import cannabis because it had been used at the planning stage at a time when the conspiracy was on foot. The DPP obtained an ex parte restraining order against the plane. However, the DPP was conscious of the fact that the plane was normally used in a legitimate business and that there was no assurance that a court would agree that the plane was tainted property. Accordingly, the DPP did not seek to remove the plane from the owner or to prevent it from being used by the flying school. The restraining order was designed to prevent the owner from parting with possession of the plane pending completion of the prosecution, or variation of the restraining order.

The owner of the plane subsequently brought proceedings in the Supreme Court of South Australia seeking to have the restraining order revoked. After hearing evidence and submissions, the Court ruled in favour of the owners, finding in effect, that the defendants had abandoned the proposal to use the relevant plane before it became tainted property.

The case provides a precedent on the concept of tainted property and on the way to structure restraining orders in a case where the property in question is an asset of a business.

The prosecution is proceeding.

## **Ramdhun**

On 21 July 1995, following the conviction of Ramdhun in the ACT Supreme Court on 13 charges of defrauding the Commonwealth, the DPP obtained a pecuniary penalty order for \$1.4 million and an order forfeiting to the Commonwealth property acquired by Ramdhun from the proceeds of the offences. Over \$610 000 has been recovered from the realisation of part of the forfeited property and further recovery will be effected when three home units on the Gold Coast are sold.

**Table 1: Confiscated Assets Trust Fund: 1995 funding round**

<b>Agency</b>	<b>Project</b>	<b>Amount of grant</b>
<b>DIMA</b>	<b>Improvements to MAL system</b>	<b>\$290 000</b>
<b>ABCI</b>	<b>ACID enhancement</b>	<b>\$411 800</b>
<b>AFP</b>	<b>PISTOL/MODE</b>	<b>\$1 400 000</b>
<b>AG's</b>	<b>Forum for discussion of rules of court</b>	<b>\$20 000</b>
<b>AG's</b>	<b>AIJA conference on court procedures and technology</b>	<b>\$130 000</b>
<b>AIC</b>	<b>Modernisation of IT system</b>	<b>\$476 000</b>
<b>ISC</b>	<b>Communication systems</b>	<b>\$452 000</b>
<b>NCA</b>	<b>Telecommunications interception capacity</b>	<b>\$1 800 000</b>
<b>CLEB</b>	<b>FLAG</b>	<b>\$548 575</b>
<b>ASC</b>	<b>NETMAP</b>	<b>\$130 000</b>
<b>Total</b>		<b>\$5 406 375</b>



[Return to the Annual Report Table of Contents](#)









[Return to the DPP Home Page](#)



 [Annual Report 1995-96](#)

  [Chapter 6 - Law Reform and Other Issues](#)

-  [Crimes Amendment \(Controlled Operations\) Act](#)
-  [Model Criminal Code](#)
-  [Witness Expenses](#)
-  [Section 68 Of The Judiciary Act](#)
-  [Admissibility Of Telephone Intercept Material In Bail Applications](#)
-  [Recovery Of Investigation Costs](#)
-  [Evidence Act](#)



[Return to the Annual Report Table of Contents](#)



[Return to the DPP Home Page](#)



## Chapter 6

### Law Reform and Other Issues

One of the objectives of the DPP is to provide sound, constructive and timely recommendations on laws or proposed laws of the Commonwealth relating to the criminal justice system. The DPP is uniquely placed to identify deficiencies in the application of existing laws, as well as to assess proposals for law reform in the light of operational experience. This chapter outlines some of the areas in which the DPP was active in 1995-96. It also deals with a number of other issues of general importance.

#### Crimes Amendment (Controlled Operations) Act

*The Crimes Amendment (Controlled Operations) Act 1996* commenced operation on 8 July 1996. This legislation was the subject of close parliamentary scrutiny, including a reference to the Senate Legal and Constitutional Legislation Committee. The legislation was enacted in response to the High Court's decision in *Ridgeway v R* (1995) 129 ALR 41. That decision was the subject of a detailed note in last year's Annual Report.

The DPP provided a written submission to the Senate committee, and the Director gave evidence to the committee on 13 September 1995. Apart from dealing with the implications of the High Court's decision for law enforcement generally, the DPP submission dealt with a number of issues which were raised during debate on the Bill in the Parliament. One of those issues was whether the legislation should provide for participation in a controlled operation to be approved by a judicial officer. It was the view of the DPP that the involvement of judges in what are essentially operational matters would be inappropriate. Further, there was the question whether the conferral of such a function on a judicial officer, albeit as *persona designata*, would infringe the doctrine of separation of powers.



[Return to the Annual Report Table of Contents](#)



[Return to the DPP Home Page](#)





## Model Criminal Code

As noted in last year's Annual Report, in 1995 Parliament enacted the *Criminal Code Act 1995*. That Act implements the various recommendations made by the Model Criminal Code Officers Committee (MCCOC) in its December 1992 report on the general principles of criminal responsibility.

In December 1995, MCCOC released its final report on that part of the Model Criminal Code dealing with theft, fraud, bribery and related offences. This aspect of the Model Criminal Code exercise is of considerable importance to the Commonwealth as over half of the prosecutions conducted by the DPP are for fraud related offences.

The Attorney-General's Department is examining the recommendations made in the December 1995 report in so far as they affect the Commonwealth, and the DPP has provided a number of submissions to the Department in relation to the report.

The report builds on the significant work of the English Criminal Law Revision Committee which resulted in the enactment in the UK of the *Theft Act 1968*. That Act has already been adopted in a number of Australian jurisdictions.

The UK Theft Act model swept away many of the technicalities and anomalies of the common law in this area but it has not been without its difficulties. One of the problems raised by case law on the English Act and the Victorian version of that Act is the extent to which the basic offences of theft and obtaining property by deception overlap. The solution adopted by the ACT in its version of the Theft Act was to merge the two offences into one offence, but MCCOC has adopted a recommendation by the DPP that the two offences should be made mutually exclusive.

The DPP does not agree with the recommendation by MCCOC that the Model Criminal Code should not contain a general dishonesty offence on the lines of the existing section 29D of the Crimes Act. In that regard, MCCOC recently released a discussion paper on conspiracy to defraud in which it recommended that a codified form of that offence should be included in the Model Criminal Code. The DPP's view is that if it is to be an offence under the Model Criminal Code for two or more people to agree to influence by dishonest means the exercise of a public duty, or by dishonest means to cause a person to suffer a loss, as a matter of logic it should be an offence for an individual acting alone to actually achieve those same objectives by dishonest means. The omission of a general dishonesty offence from the Commonwealth's version of the Model Criminal Code - the *Criminal Code Act 1995* - would significantly weaken the capacity of law enforcement agencies to deal with fraud on the revenue.

For the reasons indicated in the 1993-94 Annual Report, the DPP also does not agree with MCCOC's recommendations concerning the element of dishonesty in the context of the proposed offences of theft and obtaining property or a financial advantage by deception. Apart from philosophical objections to the MCCOC recommendations, there are problems of a more practical nature. There is a clear potential for inconsistency in verdicts and a potential for the definition proposed by MCCOC to lead to more, longer and more difficult trials.



[Return to the Annual Report Table of Contents](#)



[Return to the DPP Home Page](#)





## Witness Expenses

Witnesses who give evidence in Commonwealth prosecutions are entitled, at common law and under statute, to the payment of reasonable expenses for travel and for meals and accommodation where necessary. At common law there is no entitlement to compensation for income lost by reason of attendance at court to give evidence, but it has been recognised that as an incident of the subpoena power of a court a witness may be entitled to some compensation for loss of income. In some jurisdictions a statutory maximum is set.

The DPP has developed a policy addressing the basis on which payments will be made to non-expert witnesses in respect of the loss of income and the procedure for claiming payment. There is no upper limit to the amount that may be claimed, but witnesses will be required to establish that an actual loss was sustained and the amount of that loss. They will also be required to mitigate any loss by rescheduling work where possible.

The budgetary implications of the policy are not great as most non-expert witnesses in Commonwealth prosecutions are Commonwealth officers, such as AFP members, who do not suffer any loss of income as a result of attending court to give evidence.



---

[Return to the Annual Report Table of Contents](#)



[Return to the DPP Home Page](#)

---



## Section 68 Of The Judiciary Act

The DPP has suggested that the Attorney-General's Department consider an amendment to the *Judiciary Act 1903* so that provisions such as section 359AA of the Victorian Crimes Act can apply to proceedings on indictment for an offence against Commonwealth law. In broad terms, that section of the Victorian Act enables a court in a trial of an indictable offence to also hear and determine a related summary offence.

Section 68(2) of the Judiciary Act confers on State courts exercising jurisdiction with respect to offences against State law a like jurisdiction with respect to offences against Commonwealth law. However, section 68(3) restricts the federal jurisdiction of State courts with respect to summary offences to magistrates. The effect of the subsection is to preclude a superior court in Victoria from adopting the section 359AA procedure in Commonwealth matters. It is highly unlikely that such a result was intended. It would therefore seem appropriate that section 68(3) be amended to confine that provision to the exercise of federal jurisdiction by courts of summary jurisdiction.



[Return to the Annual Report Table of Contents](#)



[Return to the DPP Home Page](#)



## Admissibility Of Telephone Intercept Material In Bail Applications

In *DPP (NSW) v Serratore* (1995) 132 ALR 461, the NSW Court of Appeal unanimously held that evidence of lawfully obtained telephone intercepts is not admissible on the hearing of a bail application as such an application is not a "proceeding by way of a prosecution" for the purposes of paragraph (a) of the definition of "exempt proceeding" in section 5B of the *Telecommunications (Interception) Act 1979*. The consequence of the decision is that there is a risk that defendants in both federal and state matters may be granted bail where bail would be refused if the prosecution was able to place all relevant material before the court.

The DPP has recommended that the Telecommunications (Interception) Act be amended to allow lawfully obtained telephone intercepts to be admitted into evidence on the hearing of a bail application. The Office has also drawn attention to anomalies of a similar nature that may arise in respect of other proceedings, such as applications for search warrants and for production and monitoring orders under the Proceeds of Crime Act. For example, the information lawfully obtained from a telephone intercept may indicate that evidential material in relation to the offence under investigation is located at certain premises. However, at present it may not be possible for the police to rely on that information in an application for a warrant to search the premises.



[Return to the Annual Report Table of Contents](#)



[Return to the DPP Home Page](#)



## Recovery Of Investigation Costs

Section 21B of [the Crimes Act](#) enables a court to order an offender to make reparation to the Commonwealth in respect of any loss suffered or expense incurred as a result of an offence against Commonwealth law. It is the view of this Office that the section does not enable a Commonwealth agency to recover costs incurred by that agency in investigating an offence.

*In 1995 the Attorney-General's Department issued a discussion paper seeking views on this issue. The DPP submission recommended that the section be amended to specifically address the issue.*



[Return to the Annual Report Table of Contents](#)



[Return to the DPP Home Page](#)



## Evidence Act

In accordance with a recommendation by the Senate Committee on Legal and Constitutional Affairs a committee was established to monitor the operation of the Commonwealth *Evidence Act 1995*, which has now been in operation for over a year. The DPP provided a submission to the committee on the operation of the Commonwealth Act and the NSW Evidence Act, which is mirror legislation.

In 1995 the DPP wrote to the Attorney-General's Department drawing attention to limitations in the provisions of the Commonwealth Act dealing with Commonwealth records. It appears likely that the Act will be amended to widen those provisions.



[Return to the Annual Report Table of Contents](#)



















[Return to the DPP Home Page](#)

---



 [Annual Report 1995-96](#)

-   [Chapter 7 - Resource Management](#)
-  [Human Resources](#)
-  [Financial Management](#)
-  [Information Technology](#)
-  [Libraries](#)
-  [Accommodation](#)
-  [Consultancy Services](#)
-  [Fraud Control And Internal Audit](#)
-  [Public Relations](#)
-  [Reports By The Auditor-General](#)
-  [Status Of Women](#)
-  [Environmental Matters And Energy Management](#)
-  [Freedom Of Information](#)
-  [Business Regulation](#)
-  [Public Comment](#)
-  [Privacy](#)



[Return to the Annual Report Table of Contents](#)



[Return to the DPP Home Page](#)





 [Annual Report 1995-96](#)

 [Chapter 7 - Resource Management](#)

  [Human Resources](#)

 [Staffing](#)

 [Training and Development](#)

 [Staff Interchange](#)

 [Occupational Health and Safety](#)

 [Equal Employment Opportunity](#)

 [Performance Pay](#)

 [Industrial Democracy](#)



[Return to the Annual Report Table of Contents](#)



[Return to the DPP Home Page](#)



## Chapter 7

# Resource Management

Resource management in the DPP is the responsibility of Resource Management branches, both in Head Office and the regional offices, under the direction of the Senior Executive, Resource Management.

Head Office plays a coordinating role in areas of national importance, as well as providing media liaison and publishing services. Operational responsibility has largely been devolved to regional offices.

Each regional branch is headed by an Executive Officer who works under the supervision of the Deputy Director for that State. The regional branches are responsible for personnel, information technology, library and accounting services as well as general administration.

In the past, national financial and personnel management has been undertaken by separate sections. The distinction between the functions has become blurred over time and the Office has implemented a trial merger of the two sections into a single Resource Management Section. This section is headed by a Manager, assisted by a number of team leaders who specialise in the various disciplines involved.

## Human Resources

### Staffing

As at 30 June 1996 the number of staff was 440 (454 at 30 June 1995). A breakdown of this figure appears in tables I to 4 at the end of this Chapter.

Averaging staffing for the year was 443.

The staff turnover for lawyers for this year remained relatively low at eight percent. This is in contrast to turnover rates in the late 1980's which were as high as 30 percent in some regions. The low rate appears to reflect the fact that there are, at present, limited opportunities for lawyers to transfer to the private sector. The turnover rate for non-legal staff was 17 percent. Exit questionnaires suggests that people left mainly for personal reasons or to advance their careers.

There was limited staff movement in Senior Executive Service ranks, with one gain and two losses. None of the gains or losses involved intra-agency mobility.

The percentage of staff dedicated to corporate support was 24.1 percent for 1995-96. This figure comprises all staff not directly supporting legal activities, including national and regional libraries, information technology and staff involved on administrative duties.

There were no requests during the year for post separation employment under Chapter 13 of the Guidelines on Official Conduct for Commonwealth Public Servants.

## **Training and Development**

In the course of the year the DPP refined individual training agreements and local training programs in accordance with the recently revised National Training Policy and Plan. The Australian Training Register will increasingly be used as a direct and up-to-date source of information on training services and, as competency based training is introduced, for information on competencies. The computer based system, OMNI, is currently used as a primary source of information for regional and national training.

In September and October 1995 a national training program was conducted for performance appraisal. This included training on effective feedback and communication skills. National training was also conducted on the DPP's Performance Appraisal Computer System.

In the course of the year the Sydney Office organised a two day course on Managing for Performance and Maximum Productivity in conjunction with the University of Technology. The course was run on three occasions. In total, 42 lawyers and senior officers attended, which was about 70% of staff in those classifications.

Each office conducted regular in-house legal training, usually on a monthly basis. This training ensures lawyer's skills remain current and that they complete the continuing legal education requirements that apply to them. The year also saw considerable effort put into training DPP officers on CRIMS, the DPP's Case Reporting and Information Management System.

Each office also provided training on OH&S issues, including courses on stress management and ergonomics.

Many human resource and line managers also attended information sessions and workshops dealing with impending changes to the industrial framework that are likely to flow from the Workplace Relations Bill and the review of the *Public Service Act 1922*.

Net eligible expenditure on training for the year was approximately \$321 000, which is 1.6 per cent of total salary expenditure. The total number of training days was 1 160 at an average of 2.6 days per person.

## **Staff Interchange**

The DPP Interchange Program, which was settled in consultation with relevant unions, provides for one or two formal placements with local or overseas organisations in any year subject to available resources. Unfortunately, due to resource constraints, the DPP was not able to participate in any interchanges during 1995-96.

## **Occupational Health and Safety**

The DPP has an OH&S agreement with the Public Sector Union which was signed on 22 July 1992. The agreement is due to be reviewed during 1996-97.

All states have trained OH&S representatives and deputies. There was some turnover of representatives during the year which meant that new representative had to be selected and trained. There is at least one formal workplace inspection in each office during each year. During 1995-96 no problems of any significance were found to exist.

OH&S Committee meetings are held regularly in all offices. Attention is given to minimise potential problems that may result from the use of new technology, particularly soft tissue injuries using computer equipment. If problems arise, the DPP's practice is to engage specialists with the skills needed to carry out inspections and develop strategies to overcome the problem.

In March 1996 Comcare conducted a planned workplace investigation of the Melbourne Office to assess compliance with the *Occupational Health and Safety (Commonwealth Employment) Act 1991* and applicable codes of practice. The result was favourable, with high ratings given against all seven assessment categories and only two primary recommendations for improvement. Comcare noted that there was a high level of management commitment to improving health and safety within the Melbourne Office.

## **Equal Employment Opportunity**

The DPP's third Employment Equity Plan was settled in 1994 and covers the years 1994 to 1997.

Each State office has an officer responsible for the implementation of EEO under the direction of the Deputy Director. The National Resource Management section within Head Office provides control, advice and coordination for the State offices under the direction of the Senior Executive, Resource Management. An officer in Head Office is designated as the DPP's EEO coordinator. The staffing effort during the year was approximately 1.5 ASL nationally.

The statistics show that DPP employment rates for most target groups compare favourably with employment rates for the APS as a whole. The exception is Aboriginal and Torres Strait Islanders. However, an Aboriginal cadet has been selected for the Sydney Office and will commence work in December 1996.

EEO is a regular topic of discussion at the bi-annual Executive Officers' Conference and at industrial democracy meetings. All staff with EEO responsibilities attend EEO network meetings as appropriate.

Major achievements since 1 July 1995 include:

- completion and distribution of the DPP's Return to Work policy;
- revision of the DPP's Workplace Harassment Policy and the DPP's Sexual Harassment Policy; and
- EEO workshops and training in state offices.

Major EEO priorities for 1996-97 will be:

- revision of Employment Equity Plan;
- completion of the Guidelines for Home-based Work and Job Sharing;
- continued commitment to Aboriginal cadetship program;
- revision of EEO equity plans; and
- continuation of EEO awareness training.

One EEO-related grievance was lodged with the DPP and the Human Rights and Equal Opportunity Commission in 1995-96. The grievance concerned the non renewal of a temporary employment contract for a disabled employee. The matter has yet to be resolved.

Monitoring of exit questionnaires and interviews suggests that there is no general perception that the DPP discriminates against members of target groups.

The DPP's EEO profile as at 30 June 1996 is shown in table 5 at the end of this Chapter.

## Performance Pay

The DPP made payments to SES for the full 1995-96 cycle and pro-rata to eligible non-SES staff for the cycle 15 September 1995 to 30 June 1996. Details of the payments appear in tables 6, 7 and 8 at the end of this Chapter.

A Performance Appraisal Computer System was implemented in 1995-96 and is being refined. As noted above, training in using the system was conducted in late 1995.

The Office's policies on performance pay will be reviewed in light of changes proposed in the 1996-1997 APS wages package.

To date, the DPP has received no formal grievances in relation to the operation of performance appraisal or performance pay.

## Industrial Democracy

The DPP's Industrial Democracy plan was last revised and agreed with the CPSU in May 1993. It continues to work effectively and this has been recognised by both management and the Union.

Regular ID meetings are held in each region. During 1995-96, these raised such issues as office relocation, accommodation, the plateauing of senior lawyers, problems related to new technology and manual handling. The ID forum gives staff an opportunity to be involved in major decisions affecting their working environment and practices.

A National Consultative Council meeting will be held in Head Office in July 1996.

Industrial democracy is now integrated into the management methods of the DPP and there are no specific events to report.



[Return to the Annual Report Table of Contents](#)



[Return to the DPP Home Page](#)

---



 [Annual Report 1995-96](#)

 [Chapter 7 - Resource Management](#)

  [Financial Management](#)

 [Financial statements](#)

 [Program budgeting](#)

 [Financial reporting and management information systems](#)

 [Accounting Policy](#)

 [Accounts processing](#)

 [Claims and losses](#)

 [Capital works management](#)

 [Agency evaluations](#)



[Return to the Annual Report Table of Contents](#)



[Return to the DPP Home Page](#)

---



## Financial Management

### Financial statements

Audited financial statements for the DPP are included at the end of this report. The DPP's total revenue and expenses over the last four years, and the budget for 1996-97, are shown in table 9 at the end of this Chapter. Details of expenditure against appropriation are shown in table 10.

Total expenditure for 1995-96 was \$52.22 million, against an appropriation of \$58.27 million. The expenditure for 1994-95 was \$43.37 million against an appropriation of \$49.59 million.

The increase in expenditure over 1994-95 was due primarily to increased wage costs resulting from wage increases, costs relating to the relocation of Head Office, IT re-equipment and the cost of running a number of major cases.

The underspending against appropriation resulted from the deferral of aspects of the IT re-equipment program while software is evaluated and the reservation of funds to meet spending commitments in 1996-97.

### Program budgeting

The DPP has three sub-programs for the purposes of external reporting: Commonwealth Prosecutions (which includes corporate prosecutions), Criminal Assets, and Executive and Support (which includes the IT re-equipment project). Details of the activities carried out under each sub-program appear in the relevant chapters of this report. The expenditure incurred in respect of each program appears in the financial statements at the end of this report.

For further information on the DPP budget refer also to the Attorney-General's Program Budget Measures Statements 1995-96 - Sub-program 6.7 and Attorney-General's Portfolio Budget Statements 1995-96 Sub-program 6.7.

### Financial reporting and management information systems

The DPP operates three key management information systems, the FINEST financial management information system, the Fines and Costs system and the NOMAD personnel management information system.

### Accounting Policy

The DPP Financial and Purchasing Handbooks will need to be amended to incorporate the effect of the proposed Financial Management and Accountability Act. The current handbooks remain in force until that occurs.

During 1995-96 the DPP failed to gazette purchases in excess of \$2 000 within the required time-frame on a number of occasions due to failures in office procedures. Such purchases were subsequently gazetted later, but outside the required reporting period.

## **Accounts processing**

The DPP plans to review its accounts processing practices and the degree of devolution of financial responsibility in conjunction with the move to an accrual accounting environment. The higher skill levels required under the new system may mean that some processes that have been decentralised may have to be re-centralised.

Australian Government credit cards are used where practicable, and are proving to be an efficient way of paying claims.

In 1995-96 the DPP processed 11 044 claims for payment nationally by cheque or credit card (11 319 in 1994-95). Ninety six percent were paid on the due date (92 per cent in 1994-95). In smaller offices it is cost effective to process batches of claims at regular intervals, rather than to process small numbers of claims strictly on the due date.

## **Claims and losses**

The DPP had no claims or losses which individually resulted in net costs to the Commonwealth of \$50 000 or more during 1995-96.

The DPP had no claims which resulted in costs to the Commonwealth in aggregate in the ranges \$10 000 to \$20 000 and \$20 000 to \$50 000.

## **Capital works management**

The DPP had no major capital works projects costing \$6 million or more in 1995-96.

## **Agency evaluations**

The DPP developed an evaluation plan in 1990-91. The plan provides for the evaluation of significant DPP activities in a five-year cycle. In past years, the criminal assets, fines and costs and information technology functions have all been reviewed.

In 1992-93 the DPP was represented on a portfolio review of the corporate prosecutions function which established an ongoing funding base for corporate prosecutions.

In 1993-94 the DPP participated with the Department of Finance and the Attorney-General's Department in a tripartite review of the Office as a whole.

Accordingly, all major activities of the Office have been reviewed in recent years.



[Return to the Annual Report Table of Contents](#)



[Return to the DPP Home Page](#)

---





Commonwealth **Annual Report**  
Director of Public Prosecutions **1995-96**

 [Annual Report 1995-96](#)

 [Chapter 7 - Resource Management](#)

  [Information Technology](#)

 [Computer re-equipment](#)



[Return to the Annual Report Table of Contents](#)



[Return to the DPP Home Page](#)



## Information Technology

### Computer re-equipment

The DPP computer installation is made up of IBM-compatible personal computer local and wide area networks, with in-house applications running in a client-server environment. The wide area network provides gateways to external services and to some other Commonwealth agencies.

Two WANG VS minicomputers in Head Office run the financial and library management systems (FINEST and LIBMAN). Both of the minicomputers are likely to be decommissioned by the end of 1996-97 when the systems are replaced or transferred to the DPP's client-server environment.

In addition to FINEST and LIBMAN the DPP maintains the following in-house systems:

- Case Recording and Information Management System (CRIMS), which records information and progress of prosecution matters being dealt with by the DPP;
- Fines and Costs (FAC), which records and disperses fines and costs imposed by courts;
- Criminal Assets Recording System (CARS), which records and tracks action by the Criminal Assets branches; and
- File Registry System (FILE), which keeps a record of administration files.

In 1995 the CRIMS system was awarded the Australian Information Industry (AIIA) Award for excellence in information technology. Interest in the system has been shown by a number of State DPP's as well as some South East Asian countries.

The DPP has developed its own computer court presentation system called CLARITY which assists with the preparation, management and presentation of evidence in complex cases.

The system has a number of applications, including spreadsheets and text retrieval as well allowing the use of databases to record and display imaged documents.

The CLARITY system has been used successfully in NSW, Victoria, WA and the ACT in cases ranging from money laundering to corporate prosecutions. The use of CLARITY has greatly accelerated the speed with which documents can be tendered and has assisted in simplifying complex matters. The system, which is fully portable, has cut court time in all cases where it has been used.



[Return to the Annual Report Table of Contents](#)



[Return to the DPP Home Page](#)





## Libraries

The DPP libraries operate as a network providing legal material, reference and information services in each office and across the network. All libraries have access to local and overseas databases. Local Area Networks enable the librarians to provide desktop access to internal databases and commercial legal applications on disk and CD-ROM.

There are professional librarians in each office who provide services to their office and keep other offices informed of local legal developments. The librarians meet regularly and are consulted in the development of library policies and procedures. The Head Office librarians also perform a national role maintaining in-house databases, producing a weekly newsletter for librarians and editing a monthly legal information service for lawyers. The systems / cataloguing librarian maintains the library management system and is responsible for network cataloguing.

The in-house databases contain opinions, speeches, media reports, internal newsletters, documents and manuals, legal abstracts and legislation. Scanning equipment is used to add material not available in electronic form. The DPP uses the ISYS text retrieval system for most of its in-house databases and for those commercial databases which do not have their own text retrieval system.

The Office plans to implement a new library management system, compatible with the present IT environment, in 1996-97.



[Return to the Annual Report Table of Contents](#)



[Return to the DPP Home Page](#)



## Accommodation

In 1995-96 the DPP spent approximately \$4.8 million on accommodation and occupied a total of 16 465 square metres (\$3 million and 16 467 square metres in 1994-95). A breakdown of these figures appears in table 11 at the end of this Chapter.

The rent increase occurred as rent free periods expired on some leases.

During the year the DPP finalised a new lease for Head Office and that office will relocate in July 1996.



[Return to the Annual Report Table of Contents](#)



[Return to the DPP Home Page](#)



## Consultancy Services

Details of expenditure by the DPP in 1995-96 under consultancy agreements and systems integration contracts are shown in table 12 at the end of this Chapter.

Total expenditure for the year was \$440 500, a large part of which relates to the cost of relocating Head Office and the salaries of in-house counsel.



[Return to the Annual Report Table of Contents](#)



[Return to the DPP Home Page](#)



## Fraud Control And Internal Audit

The DPP issued its current Fraud Control Plan in 1995. The review of fraud control is carried out under contract by Ernst and Young as part of the internal audit process.

There were no cases of internal fraud reported during the year and there were no relevant disciplinary proceedings under the Public Service Act.



[Return to the Annual Report Table of Contents](#)



[Return to the DPP Home Page](#)



## Public Relations

All media inquiries are handled by an Executive Assistant who works in Head Office and can be contacted on (06) 2065606 during office hours.

The DPP's policy is to provide accurate information on any matter which is on the public record. However, the DPP will generally not disclose information on cases that are yet to come before the courts.

The Executive Assistant also provides a daily media summary to each DPP officer via the computer network. The summary forms the basis of a database which can be used for research purposes.

A corporate video, *Prosecuting in the Public Interest*, explains and illustrates the work of the Commonwealth DPP. Copies of the video are available from any DPP office.

The DPP did not undertake any advertising campaigns or market research in 1995-96.



[Return to the Annual Report Table of Contents](#)



[Return to the DPP Home Page](#)





## Reports By The Auditor-General

The DPP was referred to in one report by the Auditor-General in 1995-96. That report was No. 13 of 1995-96: *Results of 1994-95 Financial Statements Audit of Commonwealth Entities*.

The comments made in that report in respect of the DPP were that the audit report on the financial statements was unqualified and the result of the audit of the accounts and records was satisfactory.

The DPP was not referred to in any report by a Parliamentary Committee or by the Commonwealth Ombudsman.

---



[Return to the Annual Report Table of Contents](#)



[Return to the DPP Home Page](#)

---



## Status Of Women

The DPP does not have specific policies addressing the status of women, other than in relation to employment issues addressed under EEO which are dealt with above.

Given the nature of the functions the DPP performs, the Office has limited capacity to promote the status of women other than by doing its part to ensure that there is no discrimination against women in the criminal process.

The DPP does not have a women's unit. The responsibility for ensuring that proper consideration is paid to the status of women rests on the Deputy Directors.



[Return to the Annual Report Table of Contents](#)



[Return to the DPP Home Page](#)



## Environmental Matters And Energy Management

Given the nature of the DPP's work, there are limits to what the Office can do to protect the environment and conserve energy. Nonetheless, it is DPP policy to make the most efficient use of resources whenever it is possible to do so. The Office gives preference to environmentally sound products wherever possible and all office waste paper is recycled.

---



[Return to the Annual Report Table of Contents](#)



[Return to the DPP Home Page](#)

---



## Freedom Of Information

During the year seven requests were received by the DPP under the *Freedom of information Act 1982*. One request was granted in full, one request was granted in part, one request was refused, one request was transferred, one request was withdrawn and two requests were outstanding as at 30 June 1996. Of the requests dealt with, four were dealt with within 30 days and one request within 60 days.

---



[Return to the Annual Report Table of Contents](#)



[Return to the DPP Home Page](#)

---



## Business Regulation

The DPP has no role in business regulation other than to prosecute criminal offences in appropriate cases. The DPP's activities in corporate prosecutions are reported in Chapter 4 of this report.

---



[Return to the Annual Report Table of Contents](#)



[Return to the DPP Home Page](#)

---



## Public Comment

The DPP has no formal arrangements for inviting complaints from the general public. However, any person is free to write to the Director or to any other DPP office at the addresses shown at the front of this Report.

Much of the correspondence received during the past year was from people charged with criminal offences, or their solicitors, asking that the matter not proceed. Statistics on the results in cases where representations were made after committal appear in Chapter 2.



[Return to the Annual Report Table of Contents](#)















[Return to the DPP Home Page](#)



 [Annual Report 1995-96](#)

 [Chapter 7 - Resource Management](#)

  [Privacy](#)

-  [Table 1\(a\): Staff as at 30 June 1996](#)
-  [Table 1\(b\): Staffing summary 1995-96](#)
-  [Table 2: Staff as at 30 June 1996 by gender and category](#)
-  [Table 3: Staff usage by office](#)
-  [Table 4: Staff usage by program](#)
-  [Table 5: EEO profile of the DPP as at 30 June 1996](#)
-  [Table 6: Performance pay: Number of eligible staff and aggregate payments \(excluding superannuation\)](#)
-  [Table 7: Distribution of performance pay to Senior Officer grades and equivalents](#)
-  [Table 8: Distribution of performance pay to Senior Executive Officers](#)
-  [Table 9: DPP revenue and expenses over past five years and budget for 1996-97](#)
-  [Table 10: Actual expenditure against appropriation](#)
-  [Table 11: Accommodation costs and usage](#)
-  [Table 12: Consultancies for 1995-96](#)



[Return to the Annual Report Table of Contents](#)



[Return to the DPP Home Page](#)



## Privacy

There were no reports served on the DPP by the Privacy Commissioner under section 30 of the *Privacy Act 1988* in 1995-96.

**Table 1(a): Staff as at 30 June 1996**

Classification	ACT	NSW	Vic	Qld	SA	WA	TOTAL
Director	1						1
Associate Director	1						1
SES Band 3	2						2
Band 2		1	1	1	1	1	5
Band 1	6	9	6	6	2	3	32
Legal 2	9	29	20	8	9	9	84
Legal I	5	25	24	13	2	7	76
SITO A	1						1
SITO B	2		1				3
SITO C	2	2	1				5
ITO 2			1	1			2
ITO 1		2		1		1	4
SPO B	1						1
SPO C	1	1	1	1	1	1	6
PO 2	1	1					2



PO I	1						1
SOG A	1						1
SOG B		3	3	1	1		8
SOG C	4						4
ASO 6	3	2	2	2	1	1	11
5	2	1	1			1	5
4	6	18	11	2		4	41
3	9	19	11	11	6	11	67
2	2	20	23	6	2	1	54
I	1	3	1	2			7
Agency	2	3	1	1	4	5	16
Totals	63	139	108	56	29	45	440

Note: Inoperative staff not included: Paid 13  
Unpaid 29

Legend SES Senior Executive Service SOG Senior Officer Grade  
SITO Senior Information Technology Officer ASO Administrative Service Officer  
SPO Senior Professional Officer

**Table 1(b): Staffing summary 1995-96**

<b>Statutory Office Holders</b>		<b>2</b>
<b>Total staff employed under the PS Act</b>		<b>393</b>
<b>Total staff employed under the DPP Act</b>		<b>29</b>
<b>Agency Staff</b>		<b>16</b>
<b>Total</b>		<b>440</b>

The total number of temporary staff included in this table is 38.

**Table 2: Staff as at 30 June 1996 by gender and category**

**Full-time Part-time**

Category		Male	Female	Male	Female
Director		1			
Associate Director		1			
Senior Executive Service -					
Band 3		2			
Band 2		5			
Band 1		21	11		
Legal		78	70		12
Senior Officer & equivalent		16	11		2
ASO & equivalent		54	130	2	24
Grand total	440				

16 agency staff are included in the above figures

**Table 3: Staff usage by office**

Office	Estimated Average	Actual Average
	Staffing 1995-96	Staffing 1995-96
Head Office	63	63
NSW	157	143
Vic.	107	106
QLD	54	54
SA	32	32
WA	43	45
Total	456	443

**Table 4: Staff usage by program**

Program	Estimated average	Actual average
	staffing	staffing
Prosecutions	296	299
Criminal Assets	47	38
Executive & Support	113	106
Total	456	443

**Table 5: EEO profile of the DPP as at 30 June 1996**

Classification	Male	Female	ATSI	PWD	NESB1	NESB2
Director	1				1	
Assoc Dir.	1					

SES 3	2					
SES 2	5			1		
SES 1	21	11				3
Legal 2	46	38		1	2	10
Legal 1	32	44			2	5
SOG A/B/C & Equiv	16	13		1	2	3
ASO 1-6 & Equiv	55	139		11	11	26
<b>Total</b>	<b>179</b>	<b>245</b>		<b>14</b>	<b>18</b>	<b>47</b>

Agency staff and inoperative staff are not included in the above figures

Legend:

**ATSI:** Aboriginal and Torres Strait Islanders

**PWD:** People with disabilities

**NESB1:** Non-English Speaking Background (first generation, born overseas and whose first language was not English).

**NESB2:** Non-English Speaking Background (second generation, arrived in Australia before age five along with Australian-born people with parents of NESB).

**Note:** The above categories, other than male or female, only include officers who have voluntarily identified themselves as belonging to a particular group. The figures in the above table may accordingly be incomplete.

**Table 6: Performance pay: Number of eligible staff and aggregate payments (excluding superannuation)**

Staff Category	Number (staff years)	Aggregate Payments
SES	36.5	\$209 325
Senior Officer A/B*	131.9	\$427 330
Senior Officer C*	19.3	\$ 25 205

\* These categories include staff at equivalent levels

**Table 7: Distribution of performance pay to Senior Officer grades and equivalents**

Percentage*	0-20%	21-40%	41-60%	61-80%	81-100%
<b>No. of officers</b>	<b>2</b>	<b>47</b>	<b>84</b>	<b>29</b>	<b>8</b>

\* Percentage of maximum permissible performance pay.

**Table 8: Distribution of performance pay to Senior Executive Officers**

Percentage*	0-20%	21-40%	41-60%	61-80%	81-100%

<b>No. of officers</b>		<b>5</b>	<b>24</b>	<b>11</b>	<b>2</b>
------------------------	--	----------	-----------	-----------	----------

\* Percentage of maximum permissible performance pay.

**Table 9: DPP revenue and expenses over past five years and budget for 1996-97**

	1991-92	1992-93	1993-94	1994-95	1995-96	1996-97 (est.)
	(\$'000)	(\$'000)	(\$'000)	(\$'000)	(\$'000)	(\$'000.)
<b>Receipts</b>	1 974	1 239	1 170	3 344	2 086	2 012
<b>Expenses</b>						
<b>Appropriation</b>	52 606	51 042	52 372	49 598	58 279	58 276
<b>Actual</b>	41 341	46 041	46 974	43 370	52 220	

**Table 10: Actual expenditure against appropriation**

<b>Function</b>		1992-93	1993-94	1994-95	1995-96
		(\$'000)	(\$'000)	(\$'000)	(\$'000)
<b>Base funding</b>	<b>Appropriation</b>	35 801	37 680	37 382	43 869
	<b>Actual</b>	33 890	34 365	32 128	40 203
<b>IT re-equipment</b>	<b>Appropriation</b>	4 390	1 306	268	1 347
	<b>Actual</b>	4 001	1 493	562	469
<b>Corp. pros.</b>	<b>Appropriation</b>	4 500	11 150	11 948	13 063
	<b>Actual</b>	4 959	9 919	10 680	11 521
<b>War crimes</b>	<b>Appropriation</b>	6 351	2 236	-	-
	<b>Actual</b>	3 191	1 197	-	-
<b>Total expenses</b>	<b>Appropriation</b>	51 042	52 372	49 598	58 279
	<b>Actual</b>	46 041	46 974	43 370	52 220

**Table 11: Accommodation costs and usage**

**Program space occupied (m2) Cost (\$m)**

	1994-95	1995-96	1994-95	1995-96
<b>Prosecutions</b>	6 092	6 074	1.138	1.796
<b>Corporations</b>	2 991	3 110	.592	.984
<b>Total Pros.</b>	9 083	9 184	1.730	2.780
<b>Criminal Assets</b>	1 898	1 789	.334	.537
<b>Exec and Support</b>	4 818	5 492	.965	1.550

<b>Total</b>	<b>16 467</b>	<b>16 465</b>	<b>3.029</b>	<b>4.867</b>
--------------	---------------	---------------	--------------	--------------

**Table 12: Consultancies for 1995-96**

<b>Consultant</b>	<b>Purpose</b>	<b>Cost</b>	<b>Period</b>	<b>Reason used</b>
<b>Head Office</b>				
<b>Commonwealth Rehabilitation Service *</b>	<b>Advice on workstations</b>	<b>\$265</b>	<b>Oct. 95</b>	<b>Skills not available internally</b>
<b>Housley Communication Consultants*</b>	<b>Advice on new PABX</b>	<b>\$13 123</b>	<b>Nov. 95 - March 96</b>	<b>Skills not available internally</b>
<b>Mark Golsby*</b>	<b>Security</b>	<b>\$8 800</b>	<b>12/5/95 - 31/8/95</b>	<b>Formulation of security management plan</b>
<b>Mark Golsby*</b>	<b>Security</b>	<b>\$8 345</b>	<b>22/12/95 - 31/3/96</b>	<b>Formulation of security procedures</b>
<b>EASACT *</b>	<b>Counselling service</b>	<b>\$5 930</b>	<b>Nov. 95 - Oct. 96</b>	<b>Specialist skills not available internally</b>
<b>WT Partnership</b>	<b>Quantity surveyor</b>	<b>\$750</b>	<b>Sept. 95 - June 96</b>	<b>Expert advice during fitout</b>
<b>Lindquist Johnson</b>	<b>Service consultancy</b>	<b>\$13 600</b>	<b>Sept. 95- June 96</b>	<b>Expert advice during fitout</b>
<b>Tennant Hydraulic Consultancy Service</b>	<b>Hydraulic services</b>	<b>\$2 000</b>	<b>Oct. 95 - Sept. 96</b>	<b>Expert advice during fitout</b>
<b>Ernst &amp; Young</b>	<b>Internal audit</b>	<b>\$20 768</b>	<b>July 95 - July 96</b>	<b>Internal audits</b>
<b>BHP IT</b>	<b>IT re-equipment</b>	<b>\$23 560</b>	<b>July 95 - July 96</b>	<b>Specialist skills not available internally</b>
<b>Murtagh Bond*</b>	<b>Structural engineering</b>	<b>\$240</b>	<b>Dec. 95 - June 96</b>	<b>Expert advice during fitout</b>
<b>Interiors Australia *</b>	<b>Architectural services</b>	<b>\$43 720</b>	<b>Sept. 95 - July 96</b>	<b>Expert advice during fitout</b>
<b>Interiors Australia *</b>	<b>Contract administration</b>	<b>\$9 000</b>	<b>Jan. 96 - July 96</b>	<b>Expert advice during fitout</b>
<b>Australian Construction Services</b>	<b>Contract documentation</b>	<b>\$1 500</b>	<b>Sept. 95 - June 96</b>	<b>Specialist skills not available internally</b>
<b>Sydney office</b>				
<b>M lerace*</b>	<b>In house counsel</b>	<b>\$126 124</b>	<b>15/6/95 - 14/7/96</b>	<b>In-house counsel</b>
<b>Davidson Trahaire*</b>	<b>Counselling services</b>	<b>\$8 885</b>	<b>1/7/95 - 30/6/96</b>	<b>Specialist skills not available internally</b>
<b>ShowCase Systems*</b>	<b>Litigation support/ court presentation</b>	<b>\$1 650</b>	<b>1/7/95 - 15/8/95</b>	<b>Specialist skills not available internally</b>
<b>Henge Systems Pty Ltd*</b>	<b>Litigation support/ court presentation</b>	<b>\$37 440</b>	<b>10/7/95 - 31/5/96</b>	<b>Specialist skills not available internally</b>

<b>Melbourne office</b>				
<b>Rhonda Tranks *</b>	<b>Training</b>	<b>\$1 095</b>	<b>18/8/95</b>	<b>Specialist skills not available internally</b>
<b>Rhonda Tranks *</b>	<b>Leadership training</b>	<b>\$1 625</b>	<b>12/9/95 &amp; 1/12/95</b>	<b>Specialist skills not available internally</b>
<b>Rhonda Tranks *</b>	<b>Individual consultation - mentoring</b>	<b>\$720</b>	<b>15/3/96</b>	<b>Specialist skills not available internally</b>
<b>HBA Health Management</b>	<b>Team Play Building Program</b>	<b>\$4 700</b>	<b>4 &amp; 7 Aug. 95</b>	<b>Specialist skills not available internally</b>
<b>Franklin Quest Aust Inc*</b>	<b>Time management</b>	<b>\$3 190</b>	<b>24/11/95</b>	<b>Specialist skills not available internally</b>
<b>Comcare *</b>	<b>OH&amp;S training</b>	<b>\$3 500</b>	<b>June &amp; July 1996</b>	<b>Specialist skills not available internally</b>
<b>Public Service &amp; Merit Protection Commission</b>	<b>EEO Training</b>	<b>\$3 252</b>	<b>Oct. 95 - April 96</b>	<b>Specialist skills not available internally</b>
<b>Occupational Services of Aust*</b>	<b>Employee Assistance Program</b>	<b>\$3 200</b>	<b>4/1/96 - 3/1/97</b>	<b>Specialist skills not available internally</b>
<b>Polson - Helen Wells*</b>	<b>Customer Service</b>	<b>\$839</b>	<b>28/6/95</b>	<b>Specialist skills not available internally</b>
<b>Brent Young</b>	<b>In house counsel</b>	<b>\$76 664</b>	<b>30/1/95 - 29/1/96</b>	<b>In-house counsel</b>
<b>Nicholas Robinson</b>	<b>In house counsel</b>	<b>\$19 166</b>	<b>2/4/96 - 1/4/96</b>	<b>In-house counsel</b>
<b>Adelaide office</b>				
<b>Collas Consulting*</b>	<b>Develop Computer Software</b>	<b>\$900</b>	<b>2 months</b>	<b>Skills not available internally</b>

Consultancies marked \* were not publicly advertised.



[Return to the Annual Report Table of Contents](#)







[Return to the DPP Home Page](#)



Commonwealth **Annual Report**  
Director of Public Prosecutions **1995-96**

 [Annual Report 1995-96](#)

-   [Chapter 8 - Prosecution and Assets Recovery Statistics](#)
-  [Part 1: Prosecution Tables](#)
-  [Part 2: Criminal Assets Tables](#)

---

 [Return to the Annual Report Table of Contents](#)

 [Return to the DPP Home Page](#)

---



## Chapter 8

### Prosecution and Assets Recovery Statistics

The following tables provide a picture of the prosecutions and civil recovery work conducted by the DPP during the year.

#### Part 1: Prosecution Tables

**Table 1 (a): Defendants dealt with summarily in 1995-96**

Outcome of summary trials

State	Defendants outstanding at 1/7/95	Defendants received during year	Defendants dealt with	Pleas of guilty	No. of trials	Defs convicted (i)	Defs acquitted	Other (ii)	Defendants outstanding at 30/6/96
NSW	645	1 197	1 469	1 183	129	79	52	155	373
Vic	285	784	813	693	29	17	14	89	256
Qld	253	873	876	760	38	27	16	73	250
WA	166	528	516	447	35	34	16	19	178
SA	270	425	471	296	23	16	11	148	224
Tas	306	354	337	202	22	10	12	113	323
NT	69	199	135	123	12	9	3		133
ACT	104	225	225	182	18	11	7	25	104
Total	2 098	4 585	4 842	3 886	306	203	131	622	1 841

**Notes: (i) Where a defendant was convicted on at least one charge.**

**(ii) Includes cases where a defendant did not appear and where the prosecution was withdrawn.**

**Table 1(b): Defendants dealt with on indictment in 1995-96**

Outcome of summary trials

State	Defendants outstanding at 1/7/95	Defendants committed during year	Defendants dealt with	Pleas of guilty	No. of trials	Defs convicted (i)	Defs acquitted	Other (ii)	Defendants outstanding at 30/6/96
NSW	161	206	206	141	42	32	7	26	161



Vic	89	106	107	77	15	12	8	10	88
Qld	67	86	114	74	23	18	10	12	39
WA	66	68	66	37	13	14	5	10	68
SA	24	23	26	13	6	5	1	7	21
Tas	5		3		3	1	2		2
NT	8	6	9	3	1		5	1	5
ACT	13	14	14	5	4	4	4	1	13
Total	433	509	545	350	107	86	42	67	397

Notes: (i) Where a defendant was convicted on at least one charge.

(ii) eg. jury unable to agree on verdict, trial aborted, defendant found unfit to plead or defendant did not appear.

**Table 2(a): Legislation: defendants dealt with summarily in 1995-1996**

Legislation	NSW	Vic	Qld	WA	SA	Tas	ACT	NT	Total
Air Navigation Act	5								5
Australian Citizenship Act		1	2	1					4
Australian Federal Police Act	8	2	3	3			1		17
Australian National Railways Act					4				4
Bankruptcy Act	10	11	5	1	3	5	3		38
Census and Statistics Act	2								2
Civil Aviation Act	5	1	26	7	5			1	45
Commonwealth Electoral Act		3							3
Copyright Act	4		3		1				8
Crimes Act	207	150	89	67	138	26	40	12	729
Crimes (Aviation) Act	3		1						4
Crimes (Currency) Act	13	1	6	11	7	3	1		42
Customs Act	30	19	31	15		2		3	100
Companies Code	4		1		1	1			7
Corporations Law	7	3	10	4	7	7	2	1	41
Export Control Act	6	1	2	1	7				17
Family Law Act			1			1			2
Federal Airports Corporation Act					2			2	4
Financial Transaction Reports Act	35	16	16	8	2		1		78
Fisheries Management Act	3	2	1	103				64	173
Grt Barrier Reef Marine Park Act			60						60
Health Insurance Act	13	2	1	3	1				20
Marriage Act		3	1		1				5
Migration Act	93	5	12	29	1		1	1	142

<b>National Health Act</b>	<b>1</b>	<b>1</b>		<b>1</b>	<b>1</b>				<b>4</b>
<b>Non-Commonwealth legislation</b>	<b>18</b>	<b>17</b>	<b>11</b>	<b>37</b>	<b>5</b>	<b>4</b>	<b>16</b>	<b>1</b>	<b>109</b>
<b>Passports Act</b>	<b>18</b>	<b>8</b>	<b>3</b>		<b>4</b>		<b>1</b>		<b>34</b>
<b>Public Order (Prot of P &amp; P) Act</b>			<b>4</b>	<b>19</b>			<b>8</b>	<b>1</b>	<b>32</b>
<b>Quarantine Act</b>	<b>1</b>	<b>1</b>	<b>3</b>	<b>1</b>				<b>2</b>	<b>8</b>
<b>Radiocommunications Act</b>		<b>1</b>	<b>3</b>			<b>3</b>			<b>7</b>
<b>Service and Exec. of Process Act</b>							<b>6</b>		<b>6</b>
<b>Social Security Act</b>	<b>846</b>	<b>521</b>	<b>496</b>	<b>162</b>	<b>230</b>	<b>271</b>	<b>121</b>	<b>31</b>	<b>2678</b>
<b>Statutory Declarations Act</b>	<b>6</b>								<b>6</b>
<b>Student Assistance Act</b>	<b>29</b>	<b>15</b>	<b>15</b>	<b>22</b>	<b>13</b>	<b>6</b>		<b>7</b>	<b>107</b>
<b>Taxation legislation</b>	<b>81</b>	<b>25</b>	<b>49</b>	<b>10</b>	<b>20</b>	<b>3</b>	<b>22</b>	<b>5</b>	<b>215</b>
<b>Telecommunications Act</b>	<b>2</b>	<b>1</b>		<b>1</b>	<b>3</b>				<b>7</b>
<b>Therapeutic Goods Act</b>	<b>2</b>	<b>2</b>		<b>3</b>					<b>7</b>
<b>Torres Strait Fisheries Act</b>			<b>5</b>						<b>5</b>
<b>Trade Marks Act</b>	<b>5</b>				<b>6</b>				<b>11</b>
<b>Veterans Entitlements Act</b>	<b>5</b>	<b>1</b>	<b>5</b>	<b>1</b>	<b>4</b>				<b>16</b>
<b>Wildlife Prot. (Reg of E &amp; I) Act</b>	<b>1</b>		<b>2</b>	<b>1</b>					<b>4</b>
<b>Other</b>	<b>6</b>		<b>9</b>	<b>5</b>	<b>5</b>	<b>5</b>	<b>2</b>	<b>4</b>	<b>36</b>
<b>Total</b>	<b>1469</b>	<b>813</b>	<b>876</b>	<b>516</b>	<b>471</b>	<b>337</b>	<b>225</b>	<b>135</b>	<b>4842</b>

Table 2(b): *Crimes Act 1914*: defendants dealt with summarily in 1995-96

	<b>NSW</b>	<b>Vic</b>	<b>Qld</b>	<b>WA</b>	<b>SA</b>	<b>Tas</b>	<b>ACT</b>	<b>NT</b>	<b>Total</b>
<b>Incitement (s.7A)</b>		<b>1</b>		<b>1</b>					<b>2</b>
<b>Breach of recog. (ss. 20A, 20AC)</b>	<b>5</b>	<b>1</b>	<b>1</b>		<b>11</b>			<b>2</b>	<b>20</b>
<b>Damage property (s.29)</b>	<b>3</b>	<b>1</b>	<b>1</b>	<b>2</b>	<b>3</b>				<b>10</b>
<b>False pretences (s.29A)</b>	<b>6</b>				<b>4</b>	<b>2</b>		<b>1</b>	<b>13</b>
<b>Imposition (s.29B)</b>	<b>92</b>	<b>23</b>	<b>8</b>	<b>18</b>	<b>21</b>	<b>2</b>	<b>10</b>	<b>2</b>	<b>176</b>
<b>False statements (s.29C)</b>			<b>1</b>	<b>1</b>	<b>1</b>	<b>3</b>			<b>6</b>
<b>Fraud (s.29D)</b>	<b>1</b>	<b>39</b>	<b>11</b>	<b>5</b>	<b>1</b>	<b>4</b>	<b>6</b>		<b>67</b>
<b>Seizing Cth goods (s.30)</b>	<b>1</b>				<b>1</b>				<b>2</b>
<b>Admin. of justice (ss.32-50)</b>	<b>2</b>		<b>3</b>				<b>1</b>	<b>1</b>	<b>7</b>
<b>Forgery etc (ss.65-69)</b>	<b>18</b>	<b>14</b>	<b>11</b>	<b>5</b>	<b>9</b>	<b>3</b>	<b>1</b>		<b>61</b>
<b>Disclosure of information (s.70)</b>	<b>1</b>		<b>1</b>				<b>2</b>	<b>1</b>	<b>5</b>
<b>Stealing or receiving (s.71)</b>	<b>11</b>	<b>6</b>	<b>10</b>	<b>3</b>	<b>5</b>	<b>3</b>	<b>9</b>	<b>1</b>	<b>48</b>
<b>Falsification of books (s.72)</b>	<b>1</b>	<b>1</b>	<b>1</b>				<b>2</b>		<b>5</b>
<b>Bribery (ss.73 &amp; 73A)</b>	<b>6</b>								<b>6</b>
<b>Personating public officers (s.75)</b>	<b>1</b>	<b>2</b>							<b>3</b>
<b>Resisting public officers (s.76)</b>	<b>3</b>		<b>2</b>	<b>4</b>	<b>2</b>	<b>2</b>			<b>13</b>
<b>Computer offences (ss 76B - 76E)</b>	<b>24</b>	<b>6</b>	<b>1</b>	<b>5</b>		<b>1</b>			<b>37</b>

<b>Postal offences (ss 85E - 85ZA)</b>	<b>12</b>	<b>7</b>	<b>6</b>	<b>10</b>	<b>7</b>	<b>1</b>	<b>2</b>		<b>45</b>
<b>Telecom. offs (ss. 85ZB 85ZKB)</b>	<b>11</b>	<b>44</b>	<b>31</b>	<b>10</b>	<b>55</b>	<b>5</b>	<b>7</b>	<b>3</b>	<b>166</b>
<b>Conspiracy (s.86)</b>	<b>3</b>								<b>3</b>
<b>Conspiracy to defraud (s.86A)</b>		<b>3</b>							<b>3</b>
<b>Trespass on Cth land (s.89)</b>	<b>4</b>			<b>1</b>	<b>18</b>				<b>23</b>
<b>Other</b>	<b>2</b>	<b>2</b>	<b>1</b>	<b>2</b>				<b>1</b>	<b>8</b>
<b>Total</b>	<b>207</b>	<b>150</b>	<b>89</b>	<b>67</b>	<b>138</b>	<b>26</b>	<b>40</b>	<b>12</b>	<b>729</b>

Table 2(c): Legislation: defendants dealt with on indictment in 1995-96

<b>Legislation</b>	<b>NSW</b>	<b>Vic</b>	<b>Qld</b>	<b>WA</b>	<b>SA</b>	<b>Tas</b>	<b>ACT</b>	<b>NT</b>	<b>Total</b>
<b>Bankruptcy Act</b>		<b>3</b>	<b>1</b>	<b>2</b>	<b>1</b>				<b>7</b>
<b>Civil Aviation Act</b>			<b>2</b>						<b>2</b>
<b>Companies Code</b>	<b>9</b>	<b>2</b>	<b>4</b>	<b>10</b>	<b>1</b>		<b>1</b>		<b>27</b>
<b>Corporations Law</b>	<b>1</b>		<b>1</b>		<b>2</b>	<b>2</b>			<b>6</b>
<b>Crimes Act</b>	<b>106</b>	<b>56</b>	<b>69</b>	<b>24</b>	<b>9</b>	<b>1</b>	<b>9</b>		<b>274</b>
<b>Crimes (Currency) Act</b>	<b>5</b>		<b>4</b>	<b>1</b>	<b>1</b>			<b>1</b>	<b>12</b>
<b>Customs Act</b>	<b>69</b>	<b>29</b>	<b>14</b>	<b>18</b>	<b>2</b>			<b>8</b>	<b>140</b>
<b>Financial Transaction Rep. Act</b>	<b>4</b>	<b>2</b>	<b>2</b>	<b>2</b>	<b>2</b>				<b>12</b>
<b>Migration Act</b>	<b>3</b>	<b>2</b>							<b>5</b>
<b>Non-Commonwealth legislation</b>	<b>1</b>	<b>8</b>	<b>5</b>	<b>8</b>					<b>22</b>
<b>Passports Act</b>	<b>2</b>								<b>2</b>
<b>Secret Commissions Act</b>		<b>3</b>					<b>4</b>		<b>7</b>
<b>Social Security Act</b>	<b>1</b>	<b>1</b>			<b>3</b>				<b>5</b>
<b>Telecommunications (Int.) Act</b>			<b>2</b>						<b>2</b>
<b>Wildlife Prot. (Reg. of E &amp; I) Act</b>			<b>4</b>	<b>1</b>	<b>1</b>				<b>6</b>
<b>Other</b>	<b>5</b>	<b>1</b>	<b>6</b>		<b>4</b>				<b>16</b>
<b>Total</b>	<b>206</b>	<b>107</b>	<b>114</b>	<b>66</b>	<b>26</b>	<b>3</b>	<b>14</b>	<b>9</b>	<b>545</b>

Table 2(d): Crimes Act 1914: defendants dealt with on indictment in 1995-96

	<b>NSW</b>	<b>Vic.</b>	<b>Qld</b>	<b>WA</b>	<b>SA</b>	<b>Tas</b>	<b>NT</b>	<b>ACT</b>	<b>Total</b>
<b>Damage property (s.29)</b>	<b>1</b>	<b>1</b>							<b>2</b>
<b>False pretences (s.29A)</b>	<b>3</b>			<b>1</b>					<b>4</b>
<b>Imposition (s.29B)</b>	<b>62</b>	<b>6</b>	<b>5</b>	<b>1</b>	<b>3</b>	<b>1</b>		<b>1</b>	<b>79</b>
<b>False statements (s.29C)</b>				<b>1</b>				<b>1</b>	<b>2</b>
<b>Fraud (s.29D)</b>	<b>15</b>	<b>39</b>	<b>49</b>	<b>10</b>	<b>1</b>			<b>7</b>	<b>121</b>
<b>Offences relating to justice (ss.32-50)</b>	<b>2</b>	<b>1</b>		<b>1</b>	<b>1</b>				<b>5</b>
<b>Forgery etc (ss.65- 69)</b>	<b>4</b>		<b>5</b>		<b>3</b>				<b>12</b>
<b>Stealing or receiving (s.71)</b>	<b>2</b>	<b>4</b>	<b>5</b>		<b>1</b>				<b>12</b>

<b>Bribery (ss.73 and 73A)</b>	7								7
<b>Computer offences (ss.76B - 76E)</b>	1	1	1						3
<b>Espionage (Part VII)</b>									
<b>Postal offences (ss.85E - 85ZA)</b>			2	2					4
<b>Conspiracy (s.86)</b>	8			3					11
<b>Conspiracy to defraud</b>		3		4					7
<b>Other</b>	1	1	2	1					5
<b>Total</b>	106	56	69	24	9	1	0	9	274

**Table 3: Duration of trials on indictment completed in 1995-96****Number of hearing days**

State	Trials	1-5	5-10	11-15	16 - 20	21-25	26 - 30	30 plus
NSW	42	22	15	3	2			
Vic.	15	3	4	3	1	1	1	2
Qld	23	13	5	1	3	1		
WA	13	4	3	3		1		2
SA	6	3	2					1
Tas.	3	2	1					
NT	1							1
ACT	4		1					3
<b>Total</b>	<b>107</b>	<b>47</b>	<b>31</b>	<b>10</b>	<b>6</b>	<b>3</b>	<b>1</b>	<b>9</b>

**Table 4(a): Prosecution appeals in summary matters in 1995-96**

State	Appeals	Appeals against sentence		Other	
		Upheld	Dismissed	Upheld	Dismissed
NSW	8	6		2	
Vic.	4	1	1	1	1
Qld	1	1			
WA	1			1	
SA	1			1	
Tas.	1	1			
NT	1		1		
ACT	3	1	1		1
<b>Total</b>	<b>20</b>	<b>10</b>	<b>3</b>	<b>5</b>	<b>2</b>

**Table 4(b): Prosecution appeals in indictable matters in 1995-96**

State	Appeals	Appeals against sentence		Other	
		Upheld	Dismissed	Upheld	Dismissed
NSW	1		1		
Vic.	3	1	2		
Qld	2	2			
WA	2	2			
SA	2	1		1	
Tas.	0				
NT	0				
ACT	0				
<b>Total</b>	<b>10</b>	<b>6</b>	<b>3</b>	<b>1</b>	<b>0</b>

**Table 4(c) : Defence appeals from courts of summary jurisdiction in 1995-96**

State	No of appeals	Against conviction only		Against sentence only		Against conv. and sentence	
		Upheld	Dismissed	Upheld	Dismissed	Upheld	Dismissed
NSW	134		1	5	76	14	38
Vic.	50	3	1	17	9	16	4
Qld	13			8	4	1	
WA	13		2	4	3	1	3
SA	14	2	2	4	1	1	4
Tas.	2	1			1		
NT	2			2			
ACT	13	1	2	1	7		2
<b>Total</b>	<b>241</b>	<b>7</b>	<b>8</b>	<b>41</b>	<b>101</b>	<b>33</b>	<b>51</b>

**Table 4(d): Defence appeals following a conviction on indictment in 1995-96**

State	No of appeals	Against conviction only		Against sentence only		Against conv. and sentence	
		Upheld	Dismissed	Upheld	Dismissed	Upheld	Dismissed
NSW	36		2	7	12	2	13
Vic.	16		2	2	5	3	4
Qld	8		1		2		5
WA	4		2		1	1	
SA	6		2		3	1	
Tas.	1				1		

<b>NT</b>	<b>0</b>						
<b>ACT</b>	<b>1</b>				<b>1</b>		
<b>Total</b>	<b>72</b>	<b>0</b>	<b>9</b>	<b>9</b>	<b>25</b>	<b>7</b>	<b>22</b>

**Table 5: Defendants dealt with in committal proceedings in 1995-96****Outcome of defended committal proceedings**

<b>State</b>	<b>Defendants outstanding at 1/7/95</b>	<b>Defendants received during year</b>	<b>Defendants dealt with</b>	<b>Defendants committed for sentence</b>	<b>No of hearings</b>	<b>Defendants committed for trial</b>	<b>Defendants discharged</b>	<b>Other</b>	<b>Withdrawn</b>	<b>Defendants outstanding at 31/6/96</b>
<b>NSW</b>	<b>114</b>	<b>175</b>	<b>210</b>	<b>78</b>	<b>86</b>	<b>108</b>	<b>17</b>	<b>3</b>	<b>4</b>	<b>79</b>
<b>Vic</b>	<b>87</b>	<b>97</b>	<b>103</b>	<b>54</b>	<b>25</b>	<b>37</b>	<b>11</b>	<b>1</b>	<b>0</b>	<b>81</b>
<b>Qld</b>	<b>31</b>	<b>72</b>	<b>72</b>	<b>1</b>	<b>32</b>	<b>66</b>	<b>1</b>	<b>2</b>	<b>2</b>	<b>31</b>
<b>WA</b>	<b>36</b>	<b>43</b>	<b>62</b>	<b>26</b>	<b>12</b>	<b>34</b>	<b>1</b>		<b>1</b>	<b>17</b>
<b>SA</b>	<b>7</b>	<b>25</b>	<b>20</b>	<b>2</b>	<b>10</b>	<b>14</b>	<b>0</b>	<b>2</b>	<b>2</b>	<b>12</b>
<b>Tas</b>	<b>0</b>	<b>2</b>	<b>1</b>	<b>0</b>	<b>0</b>	<b>1</b>	<b>0</b>	<b>0</b>	<b>0</b>	<b>1</b>
<b>NT</b>	<b>0</b>	<b>6</b>	<b>6</b>	<b>0</b>	<b>2</b>	<b>6</b>	<b>0</b>	<b>0</b>	<b>0</b>	<b>0</b>
<b>ACT</b>	<b>6</b>	<b>17</b>	<b>12</b>	<b>3</b>	<b>7</b>	<b>8</b>	<b>0</b>	<b>1</b>	<b>0</b>	<b>11</b>
<b>Total</b>	<b>281</b>	<b>437</b>	<b>486</b>	<b>164</b>	<b>174</b>	<b>274</b>	<b>30</b>	<b>9</b>	<b>9</b>	<b>232</b>

**Table 6: Legal advice in 1995-96**

<b>State</b>	<b>General advice</b>	<b>Insufficient evidence to prosecute</b>	<b>Prosecution not appropriate advice</b>	<b>Other</b>	<b>Total</b>
<b>NSW</b>	<b>239</b>	<b>248</b>	<b>257</b>	<b>64</b>	<b>808</b>
<b>Vic.</b>	<b>141</b>	<b>158</b>	<b>194</b>	<b>48</b>	<b>541</b>
<b>Qld</b>	<b>18</b>	<b>99</b>	<b>54</b>	<b>57</b>	<b>228</b>
<b>WA</b>	<b>13</b>	<b>45</b>	<b>42</b>	<b>41</b>	<b>141</b>
<b>SA</b>	<b>23</b>	<b>77</b>	<b>55</b>	<b>25</b>	<b>180</b>
<b>Tas.</b>	<b>10</b>	<b>22</b>	<b>75</b>	<b>6</b>	<b>113</b>
<b>NT</b>	<b>39</b>	<b>25</b>	<b>9</b>	<b>2</b>	<b>75</b>
<b>ACT</b>	<b>11</b>	<b>37</b>	<b>17</b>	<b>18</b>	<b>83</b>
<b>Total</b>	<b>494</b>	<b>711</b>	<b>703</b>	<b>261</b>	<b>2169</b>

**Table 7(a): Defendants dealt with summarily in 1995-96: referring agencies**

	NSW	Vic	Qld	WA	SA	Tas	NT	ACT	Total
Airservices Australia	2								2
Australian Bureau of Statistics	2								2
Australian Customs Service	1		3	2		3	8		17
Australian Electoral Commission		3							3
Australian Federal Police	218	224	170	138	55	37	16	63	921
Australian Fisheries									
Management Authority	1						64		65
Australian Nature									
Conservation Agency	2								2
Australian Postal Corporation	20	13	8	8	5	1		4	59
Australian Quarantine and									
Insp. Service	6	2	13						21
Australian Securities Commission	11	4	10	4	8	6		2	45
Australian Taxation Office	97	26	50	13	20	5	10	24	245
Australian Telecommunications									
Authority	1	1		1					3
Civil Aviation Safety Authority	3	2	20	4	6	3	4		42
Comcare Australia			1					1	2
Dept of Defence					2			1	3
Dept of E. E. T. and Youth Affairs	19	16	20	24	15	7			101
Dept of Health and Family Services		1		1					2
Dept of Immigration and									
Multicultural Affairs	112	7	15	7	3		2		146
Dept of Primary Industries									
& Energy	3		4	2	6				15
Dept of Social Security	904	491	456	150	227	269	32	123	2652
Dept of Veterans' Affairs	6		5	1	1				13
Health Insurance Commission	10	8		9	2	1			30
National Crime Authority	2		1						4
Non-Cth agencies									
(other than State police)	6	0	62	112	9			2	191
Official Receiver	1				2	1			4
Spectrum Management Agency		1	3			4			8
State police	36	1	34	22	105				198
Telstra Corporation Limited					2				2
Other	6	12	1	18	3		1	3	44
<b>Total</b>	<b>1469</b>	<b>813</b>	<b>876</b>	<b>516</b>	<b>471</b>	<b>337</b>	<b>135</b>	<b>225</b>	<b>4842</b>

**Table 7(b): Defendants dealt with on indictment in 1995-96: referring agencies**

	NSW	Vic	Qld	WA	SA	Tas	NT	ACT	Total
<b>Australian Federal Police</b>	<b>114</b>	<b>97</b>	<b>79</b>	<b>35</b>	<b>11</b>	<b>1</b>	<b>9</b>	<b>9</b>	<b>355</b>
<b>Australian Postal Corporation</b>			<b>2</b>	<b>3</b>					<b>5</b>
<b>Australian Customs Service</b>	<b>1</b>		<b>4</b>	<b>1</b>	<b>1</b>			<b>1</b>	<b>8</b>
<b>Australian Securities Commission</b>	<b>10</b>	<b>2</b>	<b>5</b>	<b>10</b>	<b>3</b>	<b>2</b>		<b>1</b>	<b>33</b>
<b>Australian Taxation Office</b>			<b>3</b>	<b>1</b>					<b>4</b>
<b>Civil Aviation Safety Authority</b>			<b>2</b>						<b>2</b>
<b>Dept of Immig. and Multicultural Affairs</b>	<b>11</b>								<b>11</b>
<b>Dept of Social Security</b>	<b>52</b>	<b>2</b>	<b>9</b>	<b>2</b>	<b>5</b>			<b>2</b>	<b>72</b>
<b>Dept of Veterans Affairs</b>	<b>1</b>				<b>1</b>				<b>2</b>
<b>National Crime Authority</b>		<b>1</b>	<b>2</b>	<b>9</b>					<b>12</b>
<b>Non-Cth agencies (other than State police)</b>	<b>4</b>								<b>4</b>
<b>State police</b>	<b>9</b>	<b>5</b>	<b>8</b>	<b>1</b>	<b>5</b>				<b>28</b>
<b>Other</b>	<b>4</b>			<b>4</b>				<b>1</b>	<b>9</b>
<b>Total</b>	<b>206</b>	<b>107</b>	<b>114</b>	<b>66</b>	<b>26</b>	<b>3</b>	<b>9</b>	<b>14</b>	<b>545</b>



[Return to the Annual Report Table of Contents](#)



[Return to the DPP Home Page](#)







 [Annual Report 1995-96](#)

 [Chapter 8 - Prosecution and Assets Recovery Statistics](#)

  [Part 2: Criminal Assets Tables](#)

 [Table 8\(a\): PoC Act: restraining orders, pecuniary penalty orders and forfeitures obtained by DPP Criminal Assets branches in 1995-96](#)

 [Table 8\(b\): PoC Act - restraining orders in force, forfeitures unrealised and pecuniary penalty orders unpaid as at 30 June 1996](#)

 [Table 8\(c\): PoC Act - money recovered during 1995-96](#)

 [Table 9\(a\): Customs Act: restraining & pecuniary penalty orders & seizures & condemnation of property involving DPP Criminal Assets branches 1995-96](#)

 [Table 9\(b\): Customs Act: restraining orders in force, pecuniary penalty orders unpaid, seized property not condemned and condemned property not realised as at 30 June 1996](#)

 [Table 9\(c\): Customs Act - money recovered during 1995-96](#)

 [Table 10\(a\): Civil remedies - property secured, judgments and reparation orders obtained by DPP Criminal Assets branches 1995-96](#)

 [Table 10\(b\): Civil remedies - property secured, judgments and reparation orders unpaid as at 30 June 1996](#)

 [Table 10\(c\): Civil remedies: recovery of money during 1995-96](#)

 [Table 11: Criminal Assets: total recoveries 1995-96](#)



[Return to the Annual Report Table of Contents](#)



[Return to the DPP Home Page](#)



## Part 2: Criminal Assets Tables

**Table 8(a): PoC Act: restraining orders, pecuniary penalty orders and forfeitures obtained by DPP Criminal Assets branches in 1995-96**

	NSW	Vic.	SA	WA	QLD	ACT	Total
<b>No. of restraining orders obtained</b>	18	12	1	5	1		37
<b>Estimated net value of property restrained</b>	\$5 275 408	\$973 592	\$150 000	\$725 471	\$73 000		\$7 197 471
<b>No. of PPOs obtained</b>	8	3	1	4	3	1	20
<b>Value of PPOs</b>	\$590 766	\$240 136	\$20 000	\$119 423	\$145 297	\$496 214	\$1 611 836
<b>No. of S. 19 forfeitures obtained</b>	16	21	3	2	5	1	48
<b>Est. value of property forfeited under S. 19</b>	\$653 383	\$168 003	\$3 105	\$800	\$40 253	\$924 808	\$1 790 352
<b>No. of S.30 forfeitures</b>	3	2					5
<b>Est. value of property forfeited under S.30</b>	\$1 000 000	\$7 267					\$1 007 267

This table gives an indication of the amount of work done in 1995-96 by type of work.

**Table 8(b): PoC Act - restraining orders in force, forfeitures unrealised and pecuniary penalty orders unpaid as at 30 June 1996**

	NSW	Vic.	SA	WA	QLD	ACT	Total
<b>No. of restraining orders in force</b>	35	21		7			63
<b>Estimated net value of property restrained</b>	\$11 623 767	\$2 417 937		\$711 298			\$14 753 002
<b>No of S.19 forfeitures where property not realised</b>	8	17	1	1	1	1	29
<b>Estimated value of prop. forfeited</b>							

<b>under S.19 and not realised</b>	<b>\$290 107</b>	<b>\$74 959</b>	<b>\$1 500</b>		<b>\$650</b>	<b>\$314 402</b>	<b>\$682 118</b>
<b>No. of S.30 forfeitures where property not realised</b>	<b>10</b>	<b>4</b>			<b>1</b>		<b>14</b>
<b>Estimated value of prop. forfeited</b>							
<b>under S.30 and not realised</b>	<b>\$3 526 469</b>	<b>\$131 100</b>			<b>\$15 681</b>		<b>\$3 673 250</b>
<b>No. of unpaid PPOs *</b>	<b>20</b>	<b>11</b>	<b>1</b>	<b>4</b>	<b>3</b>	<b>1</b>	<b>40</b>
<b>Amount of unpaid PPOs*</b>	<b>\$1 926 713</b>	<b>\$786 099</b>	<b>\$20 000</b>	<b>\$119 423</b>	<b>\$134 840</b>	<b>\$14 900</b>	<b>\$3 001 975</b>

This table gives an indication of potential recoveries against existing orders.

\* Does not include amounts of PPOs considered to be irrecoverable.

**Table 8(c): PoC Act - money recovered during 1995-96**

	<b>NSW</b>	<b>Vic.</b>	<b>SA</b>	<b>WA</b>	<b>QLD</b>	<b>ACT</b>	<b>TOTAL</b>
<b>No. of PPOs paid</b>	<b>12</b>	<b>10</b>		<b>2</b>	<b>3</b>		<b>27</b>
<b>Amounts paid under PPOs</b>	<b>\$240 324</b>	<b>\$1 042 234</b>		<b>\$41 933</b>	<b>\$107 474</b>		<b>\$1 431 965</b>
<b>No. of S.19 forfeitures realised</b>	<b>10</b>	<b>9</b>		<b>1</b>	<b>3</b>	<b>1</b>	<b>24</b>
<b>Amounts recovered from S.19 forfeitures</b>	<b>\$579 677</b>	<b>\$110 491</b>		<b>\$300</b>	<b>\$38 971</b>	<b>\$610 406</b>	<b>\$1 339 845</b>
<b>No. of S.30 forfeitures realised</b>	<b>7</b>	<b>2</b>			<b>1</b>		<b>10</b>
<b>Amounts recovered from S.30 forfeitures</b>	<b>\$355 151</b>	<b>\$26 407</b>			<b>\$22 808</b>		<b>\$404 366</b>
<b>No of cases where amounts recovered</b>							
<b>from settlements, voluntary payments etc</b>	<b>3</b>	<b>2</b>	<b>2</b>	<b>5</b>			<b>12</b>
<b>Amounts recovered from settlements, voluntary payments etc</b>	<b>\$219 693</b>	<b>\$54 607</b>	<b>\$74 260</b>	<b>\$829 119</b>			<b>\$1 177 679</b>
<b>Total recovered</b>	<b>\$1 394 845</b>	<b>\$1 233 739</b>	<b>\$74 260</b>	<b>\$871 352</b>	<b>\$169 283</b>	<b>\$610 406</b>	<b>\$4 353 855</b>

**Note: Not all the amounts recovered will have been paid into the CAT Fund. Money recovered under settlement and other payments is not paid into the CAT Fund**

**Table 9(a): Customs Act: restraining & pecuniary penalty orders & seizures & condemnation of property involving DPP Criminal Assets branches 1995-96**

	<b>NSW</b>	<b>Vic.</b>	<b>SA</b>	<b>WA</b>	<b>QLD</b>	<b>ACT</b>	<b>Total</b>
<b>No. of restraining orders obtained</b>							

<b>Estimated value of property restrained</b>							
<b>No. of PPOs obtained</b>		<b>1</b>					<b>1</b>
<b>Amount of PPOs</b>		<b>\$5 000</b>					<b>\$5 000</b>
<b>No. of cases where property seized</b>					<b>1</b>		<b>1</b>
<b>Estimated value of seized property</b>					<b>\$30 000</b>		<b>\$30 000</b>
<b>No. of condemnations</b>	<b>3</b>	<b>7</b>		<b>1</b>			<b>11</b>
<b>Estimated value of condemned property</b>	<b>\$35 000</b>	<b>\$48 895</b>		<b>\$360 100</b>			<b>\$443 995</b>

This table sets out details of work done by the DPP Criminal Assets branches in relation to restraining and pecuniary penalty orders and forfeited property seized and condemned under the Customs Act.

**Table 9(b): Customs Act: restraining orders in force, pecuniary penalty orders unpaid, seized property not condemned and condemned property not realised as at 30 June 1996**

	<b>NSW</b>	<b>Vic.</b>	<b>SA</b>	<b>WA</b>	<b>QLD</b>	<b>ACT</b>	<b>Total</b>
<b>No. of restraining orders in force</b>		<b>3</b>					<b>3</b>
<b>Estimated net value of property restrained</b>		<b>\$525 170</b>					<b>\$525 170</b>
<b>No. of unpaid PPOs</b>		<b>3</b>					<b>3</b>
<b>Value of unpaid PPOs</b>		<b>\$37 591</b>					<b>\$37 591</b>
<b>No. of cases where seized property not condemned</b>		<b>3</b>	<b>4</b>	<b>2</b>			<b>9</b>
<b>Estimated value of seized property not condemned</b>		<b>\$47 045</b>	<b>\$84 375</b>	<b>\$10 000</b>			<b>\$141 420</b>
<b>No. of cases where condemned property not realised</b>	<b>2</b>	<b>6</b>		<b>1</b>			<b>9</b>
<b>Estimated value of condemned property not realised</b>	<b>\$13 000</b>	<b>\$64 248</b>		<b>\$220 000</b>			<b>\$297 248</b>

This table gives an indication of potential recoveries against existing orders.

**Table 9(c): Customs Act - money recovered during 1995-96**

	<b>NSW</b>	<b>Vic.</b>	<b>SA</b>	<b>WA</b>	<b>QLD</b>	<b>ACT</b>	<b>Total</b>
<b>No. of PPOs paid</b>	<b>1</b>	<b>1</b>					<b>2</b>
<b>Amounts paid under PPOs</b>	<b>\$1 108 238</b>	<b>\$9 004</b>					<b>\$1 117 242</b>

<b>No. of cases where condemned property realised</b>	<b>2</b>	<b>6</b>		<b>1</b>	<b>2</b>		<b>11</b>
<b>Amounts recovered from realisation of condemned property</b>	<b>\$26 000</b>	<b>\$49 100</b>		<b>\$360 100</b>	<b>\$40 875</b>		<b>\$475 975</b>
<b>No. of cases where amounts recovered from settlements, voluntary payments etc.</b>				<b>1</b>			<b>1</b>
<b>Amounts recovered from settlements, voluntary payments etc</b>				<b>\$4 745</b>			<b>\$4 745</b>
<b>Total amounts recovered</b>	<b>\$1 134 238</b>	<b>\$58 104</b>		<b>\$364 845</b>	<b>\$40 875</b>		<b>\$1 598 062</b>

**Table 10(a): Civil remedies - property secured, judgments and reparation orders obtained by DPP Criminal Assets branches 1995-96**

	<b>NSW</b>	<b>Vic.</b>	<b>SA</b>	<b>WA</b>	<b>QLD</b>	<b>ACT</b>	<b>TOTAL</b>
<b>No. of cases where property secured by injunction or otherwise</b>		<b>4</b>		<b>1</b>	<b>7</b>		<b>12</b>
<b>Estimated value of property secured by injunction or otherwise</b>		<b>\$259 647</b>		<b>\$40 551</b>	<b>\$808 341</b>		<b>\$1 108 539</b>
<b>No. judgments and reparation orders obtained</b>	<b>16</b>				<b>9</b>		<b>25</b>
<b>Amount of judgments and reparation orders</b>	<b>\$1 188 938</b>				<b>\$568 966</b>		<b>\$1 757 904</b>

**Table 10(b): Civil remedies - property secured, judgments and reparation orders unpaid as at 30 June 1996**

	<b>NSW</b>	<b>Vic.</b>	<b>SA</b>	<b>WA</b>	<b>QLD</b>	<b>ACT</b>	<b>Total</b>
<b>No. of injunctions or similar action in force</b>	<b>1</b>	<b>1</b>	<b>10</b>		<b>9</b>		<b>21</b>
<b>Estimated value of property secured by injunction or otherwise</b>	<b>\$1 700 000</b>	<b>\$45 000</b>	<b>\$676 000</b>		<b>\$632 952</b>		<b>\$3 053 952</b>
<b>No. of unpaid judgments and reparation orders</b>	<b>17</b>		<b>7</b>		<b>14</b>		<b>38</b>
<b>Amount of unpaid judgments and reparation orders</b>	<b>\$9 968 938</b>		<b>\$165 430</b>		<b>\$1 038 547</b>		<b>\$11 172 915</b>

This table gives an indication of potential recovery against existing orders.

**Table 10(c): Civil remedies: recovery of money during 1995-96**

	NSW	Vic	SA	WA	QLD	ACT	Total
<b>No. of judgments and reparation orders paid</b>			1		1		2
<b>Amounts paid under judgments and reparation orders</b>			\$20 045		\$2 927		\$22 972
<b>No. of cases where amounts recovered from settlements, bankruptcy etc.</b>	2	5	4	1	11		23
<b>Amounts recovered from settlements, bankruptcy etc.</b>	\$42 756	\$362 793	\$90 323	\$40 551	\$986 918		\$1 523 341
<b>Total recovered</b>	\$42 756	\$362 793	\$110 368	\$40 551	\$989 845		\$1546313

There are also civil recoveries in prosecution cases involving the Australian Tax Office and other departments in which DPP is not involved and which are not recorded in this table.

**Table 11: Criminal Assets: total recoveries 1995-96**

<b>Proceeds of Crime Act ppo</b>	1 431 965
<b>Proceeds of Crime Act s.19 forfeiture</b>	1 339 845
<b>Proceeds of Crime Act s.30 forfeiture</b>	404 366
<b>Proceeds of Crime Act settlement and other payments</b>	1 177 679
<b>Proceeds of Crime Act total</b>	\$4 353 855
<b>Customs Act ppo</b>	1 117 242
<b>Customs Act condemnation</b>	475 975
<b>Customs Act settlements and other payments</b>	4 745
<b>Customs Act total</b>	\$1 597 962
<b>Civil Remedies judgments &amp; reparations</b>	22 972
<b>Civil Remedies settlements and other payments</b>	1 523 341
<b>Civil Remedies total</b>	\$1 546 313

**Grand total**

**\$7 498 130**



[Return to the Annual Report Table of Contents](#)



[Return to the DPP Home Page](#)

---



# Appendix

## Statement under the Freedom of Information Act 1982

Under section 8(1)(b) of the *Freedom of Information Act 1982* the DPP is required to publish up-to-date information on the following matters:

(i) Particulars of the organisation and functions of the agency, indicating as far as practicable the decision-making powers and other powers affecting members of the public that are involved in those functions.

Information on this is contained throughout the annual report, but particularly [Chapter 1](#) : Office of the DPP and [Chapter 2](#) : Exercise of statutory functions and powers.

(ii) Particulars of any arrangements that exist for bodies or persons outside the Commonwealth administration to participate, either through consultative procedures, the making of representations or otherwise, in the formulation of policy by the agency, or in the administration by the agency of any enactment or scheme.

People charged with Commonwealth offences, or the subject of criminal assets proceedings, may make representations to the Director concerning the proceedings against them either directly or through their legal representatives. Any matters raised will be taken into account when a decision is made whether to continue the prosecution or the criminal assets proceedings.

(iii) Categories of documents that are maintained in the possession of the agency, being a statement that sets out, as separate categories of documents, categories of such documents, if any, as are referred to in paragraph 12(1)(b) or (c) and categories of documents, if any, not being documents so referred to, as are customarily made available to the public, otherwise than under the Act, free of charge upon request.

The following categories of documents are made available (otherwise than under the Freedom of Information Act) upon request:

- annual reports and other reports required by legislation;
- relevant media releases;
- copies of the texts of various public addresses or speeches made by the Director and other senior officers; and
- Prosecution Policy of the Commonwealth : Guidelines for the making of decisions in the prosecution process.

(iv) Particulars of the facilities, if any, provided by the agency for enabling members of the public to obtain physical access to the documents of the agency.

Facilities for the inspection of documents, and preparation of copies if required, are provided at each DPP office. Copies of all documents are not held in each office and therefore some documents can not be inspected immediately upon request. Requests may be sent or delivered to the FOI Coordinating Officer at any of the addresses set out at the beginning of this report. Business hours are 8:30 a.m. to 5:00 p.m.



Requests for access in States and Territories where there is no regional office of the DPP should be forwarded to the FOI Coordinating Officer, Attorney-General's Department, in the relevant State or Territory or to the Head Office of the DPP in Canberra.

(v) Information that needs to be available to the public concerning particular procedures of the agency in relation to Part III, and particulars of the officer or officers to whom, and the place or places at which, initial inquiries concerning access to documents may be directed to Head Office.

There are no particular procedures that should be brought to the attention of the public. Initial inquiries concerning access to documents may be made at any of the addresses referred to.



[Return to the Annual Report Table of Contents](#)



[Return to the DPP Home Page](#)

---



## Glossary

<b><i>AFP</i></b>	Australian Federal Police
<b><i>AGS</i></b>	Australian Government Solicitor
<b><i>ASC</i></b>	Australian Securities Commission
<b><i>ASX</i></b>	Australian Securities Exchange
<b><i>ATO</i></b>	Australian Taxation Office
<b><i>CAT</i></b>	Fund Confiscated Assets Trust Fund
<b><i>CPSU</i></b>	Community and Public Sector Union
<b><i>CARS</i></b>	Criminal Assets Recording System
<b><i>CRIMS</i></b>	Case Reporting and Information Management System
<b><i>EEO</i></b>	Equal Employment Opportunity
<b><i>FTR</i></b>	Act Financial Transactions Reports Act
<b><i>HOCOLEA</i></b>	Heads of Commonwealth Law Enforcement Agencies
<b><i>MCCOC</i></b>	Model Criminal Code Officers Committee
<b><i>NCA</i></b>	National Crime Authority
<b><i>PoC Act</i></b>	Proceeds of Crime Act



[Return to the Annual Report Table of Contents](#)



[Return to the DPP Home Page](#)

---



## Office Of The Director Of Public Prosecutions Independent Audit Report

### Scope

I have audited the financial statements of the Commonwealth Director of Public Prosecutions for the year ended 30 June 1996.

The statements comprise:

- Statement by the Director and Principal Accounting Officer
- Operating Statement
- Statement of Assets and Liabilities
- Statement of Program Expenses and Revenues
- Statement of Program Assets and Liabilities
- Statement of Cash Flows
- Statement of Transactions by Fund, and
- Notes to the Financial Statements.

The Director and Senior Executive Resource Management are responsible for the preparation and presentation of the financial statements and the information contained therein. I have conducted an independent audit of the financial statements in order to express an opinion on them.

The audit has been conducted in accordance with the Australian National Audit Office Auditing Standards, which incorporate the Australian Auditing Standards, to provide reasonable assurance as to whether the financial statements are free of material misstatement. Audit procedures included examination, on a test basis, of evidence supporting the amounts and other disclosures in the financial report, and the evaluation of accounting policies and significant accounting estimates. These procedures have been undertaken to form an opinion whether, in all material respects, the financial statements are presented fairly in accordance with Australian Accounting Concepts and Standards, other mandatory professional reporting requirements and statutory requirements so as to present a view of the Commonwealth Director of Public Prosecution which is consistent with my understanding of its financial position, its operations and its cash flows.

The audit opinion expressed in this report has been formed on the above basis.

### Audit Opinion

In accordance with sub-section 51 (1) of the *Audit Act 1901*, I now report that in my opinion, the financial statements:

- are in agreement with the accounts and records kept in accordance with section 40 of the Act
- are in accordance with the Guidelines for Financial Statements of Departments, and
- present fairly in accordance with Statements of Accounting Concepts, applicable Accounting Standards and other

mandatory professional reporting requirements the information required by the Guidelines including the Commonwealth Director of Public Prosecution's departmental and administered operations and its cash flows for the year ended 30 June 1996 and departmental and administered assets and liabilities as at that date.

Australian National Audit Office



Lynne O'Brien

Executive Director

For the Auditor-General

Canberra

26 September 1996

Address all mail to: GPO Box 707 CANBERRA ACT 2601

92 Centenary House 19 National Circuit BARTON ACT 2600 Phone (06) 203 7300 Fax: (06) 203 7777



[Return to the Annual Report Table of Contents](#)













[Return to the DPP Home Page](#)

---



Commonwealth **Annual Report**  
Director of Public Prosecutions **1995-96**

 [Annual Report 1995-96](#)

-   [Financial Statements 1995-96](#)
-  [Certification](#)
-  [Operating Statement](#)
-  [Statement Of Assets And Liabilities](#)
-  [Statement Of Program Expenses And Revenues](#)
-  [Statement Of Program Assets And Liabilities](#)
-  [Statement Of Cash Flows](#)
-  [Statement Of Transactions By Fund](#)
-  [Notes To The Financial Statements](#)
-  [Appendix - Glossary of Terms](#)

---

 [Return to the Annual Report Table of Contents](#)

 [Return to the DPP Home Page](#)

---



Commonwealth **Annual Report**  
Director of Public Prosecutions **1995-96**

## Office Of The Director Of Public Prosecutions

### Financial Statements 1995-96

Statement By The Director And Principal Accounting Officer

---

## Certification

We certify that the financial statements for the year ended 30 June 1996 are in agreement with the accounts and records of the Office of the Director of Public Prosecutions and, in our opinion, the statements present fairly the information required by the Guidelines for Financial Statements of Departments, issued in March 1995.

Edwin J. Lorkin  
Acting Director

S Walker  
Senior Executive,  
Resource Management.



[Return to the Annual Report Table of Contents](#)



[Return to the DPP Home Page](#)

































---



 [Annual Report 1995-96](#)

 [Financial Statements 1995-96](#)

  [Notes To The Financial Statements](#)

-  [Note 1 - Objectives](#)
-  [Note 2 - Statement Of Significant Accounting Policies](#)
-  [Note 3 - Employee Expenses](#)
-  [Note 4 - Other Administrative Expenses](#)
-  [Note 5 - Revenue](#)
-  [Note 6 - Resources Received Free Of Charge](#)
-  [Note 7 - Abnormal Revenue](#)
-  [Note 8 - Administered Expenses](#)
-  [Note 9 - Administered Revenue](#)
-  [Note 10 - Act Of Grace Payments, Waivers And Amounts Written-Off](#)
-  [Note 11 - Cash - Departmental](#)
-  [Note 12 - Receivables - Departmental](#)
-  [Note 13 - Other Current Assets](#)
-  [Note 14 - Property, Plant And Equipment](#)
-  [Note 15 - Creditors And Accruals](#)
-  [Note 16 - Provisions](#)
-  [Note 17 - Other Current Liabilities](#)
-  [Note 18 - Administered Assets](#)
-  [Note 19 - Administered Liabilities](#)
-  [Note 20 - Fines And Costs Trust Account](#)
-  [Note 21 - Residual Interest In Assets](#)
-  [Note 22 - Cash Flow Reconciliation](#)
-  [Note 23 - Receipts To The Consolidated Revenue Fund](#)
-  [Note 24 - Details Of Expenditure From Annual Appropriations](#)
-  [Note 25 - Trust Fund](#)
-  [Note 26 - Agreements Equally Proportionately Unperformed](#)
-  [Note 27 - Liabilities Not Recognised](#)
-  [Note 28 - Guarantees And Undertakings](#)
-  [Note 29 - Executive's Remuneration](#)
-  [Note 30 - Services Provided By The Auditor General](#)
-  [Note 31 - Liabilities Assumed By Other Departments](#)
-  [Note 32 - Events Occurring After Balance Date](#)



[Return to the Annual Report Table of Contents](#)



[Return to the DPP Home Page](#)



# Office Of The Director Of Public Prosecutions

## Notes To The Financial Statements

For the year ended 30 June 1996

### Note Description

8	Administered Expenses
9	Administered <a href="#">Revenue</a>

## Note 1

### Objectives

The objectives of the Office of the Director of Public Prosecutions are as follows:

- To prosecute alleged offences against the criminal law of the Commonwealth, in appropriate matters, in a manner which is fair and just.
- To ensure that offenders are deprived of the proceeds and benefits of criminal activity and to ensure the pursuit of civil remedies.
- To assist and cooperate with other agencies to ensure that law enforcement activities are effective.
- To contribute to the improvement of Commonwealth criminal law and criminal justice system generally.
- To preserve and enhance public confidence in the prosecution process and criminal justice system.
- To manage resources efficiently and provide an effective service to the Commonwealth.



[Return to the Annual Report Table of Contents](#)



[Return to the DPP Home Page](#)

---





## Note 2

### Statement Of Significant Accounting Policies:

(a) **Basis of Accounting** - The financial statements have been prepared in accordance with the 'Guidelines for Financial Statements of Departments', issued by the Minister for Finance in March 1995. The Guidelines require compliance with the Statement of Accounting Concepts, Australian Accounting Standards, Accounting Guidance Releases issued by the Australian Accounting Research Foundation and other relevant mandatory professional reporting requirements (Consensus Views of the Urgent Issues Group).

(i) The financial statements have been prepared on an accrual basis.

(ii) The financial statements have been prepared in accordance with the historical cost convention and do not take account of changing money values or [current](#) values of non-current assets except for library holdings which were valued by an expert valuer at second hand replacement value.

(iii) The continued existence of the Office in its present form, and with its present sub programs, is dependent on Government policy and on continuing appropriations by parliament for the Office's sub programs.

(b) **Comparative Figures** - Where necessary, comparative figures have been adjusted to conform with changes in presentation in these financial statements.

(c) **Rounding** - Subject to the exceptions referred to in the following paragraphs, amounts shown in the financial statements (excluding the notes) have been rounded-off as follows :

- amounts of \$500 or more have been rounded up to the next \$1,000;
- amounts less than \$500 have been rounded down to zero.

#### (c) Rounding (continued)

The rules governing rounding, referred to on the previous page, do not apply to the following items which are rounded to the nearest dollar :

- Statement of Transactions by Fund (and related notes);
- [Act of Grace Payments](#), Waivers and write-offs; and
- Executive's Remuneration.

(d) **Foreign Currencies** - Amounts paid to and by the DPP during the year in foreign currencies have been converted at the rate of exchange prevailing at the date of each transaction.

(e) **Insurance** - In accordance with government policy, assets are not insured and losses are expensed as they are incurred.

(f) **Taxation** - The Office is exempt from all forms of taxation except fringe benefits tax.

(g) **Measurement Of Assets** - Assets are recorded at cost on acquisition except as stated. The cost of acquisition includes the fair value of assets transferred in and liabilities undertaken.

Where the purchase record of an asset could not be located, the asset was valued by DPP staff (Officer's Valuation) based on the cost of a similar item of similar age.

(h) **Asset Capitalisation Threshold** - All depreciable non [current](#) assets with a historical cost equal to or in excess of \$2,000 are capitalised in the year of acquisition and included on the Office's Asset Register. The value of all such assets on the Asset Register is included in the financial statements. Assets with a historical cost under

\$2,000 are expensed in the year of acquisition except for the following:

- Library holdings were valued by an expert valuer at second hand replacement value. The \$2,000 threshold was not applied to library holdings. Only Law Reports are capitalised and all other library acquisitions are expensed in the year of acquisition. Library holdings are not depreciable and will be re-valued each five years.
- Software purchased and software developed under contract with a historical cost equal to or in excess of \$500 are capitalised and included in the Statement of Assets and Liabilities. Software having a unit cost less than \$500 are expensed in the year of acquisition. Software is depreciated over its estimated useful life. Depreciation is calculated using the straight-line method. Useful life is estimated by officers of the DPP.
- The \$2,000 threshold is not applied to Artworks. Artwork capitalised consists of originals, limited edition prints and prints. Artwork holdings are not depreciable and will be re-valued each 5 years.

**(i) Depreciation and Amortisation of Non-Current Assets** - All depreciable non-current assets are written off over their estimated useful lives. Depreciation is calculated using the straight-line method. Expected scrap value and useful life are estimated by officers of the DPP.

All fitouts are amortised on a straight line basis over the lesser of the estimated useful life of the improvements or the unexpired period of the lease. Expected scrap value and useful life are estimated by officers of the DPP.

**(j) Leases and Lease Incentives** - Operating lease payments are charged to the Operating Statement on a basis which is representative of the pattern of benefits derived from the leased assets.

Lease incentives taking the form of 'free' leasehold improvements and rent free holidays are recognised as liabilities. These liabilities are reduced by allocating lease payments between rental expense and the reduction of the [liability](#).

**(k) Employee Entitlements** - Provisions have been made for vesting employee entitlements which office employees have accumulated as a result of the rendering of their services to the Office up to the end of the reporting period. Amounts have been provided for Recreation Leave, Long Service Leave, outstanding Leave Bonus and Performance Pay, but not for Superannuation entitlements. Long Service Leave provisions have been included for officers who have accumulated more than three and a half years of service. Provisions have been apportioned between [current](#) and non-current based on previous histories of payments and known payments due. An analysis of non-vesting sick leave taken during the last 4 years determined that it was inappropriate to provide a provision for non-vesting sick leave.

**(l) Cash** - Cash includes notes and coins held, deposits held at call with a bank or financial institution and balances of commercial trust accounts held in the Commonwealth Public Account (CPA).

**(m) Departmental and Administered Items**

#### ***Departmental***

Departmental assets, liabilities, revenues and expenses are those items that are controlled by the Office including:

- Computers, Furniture, Plant and Equipment and Software used in providing goods and services;
- Liabilities for Employees Entitlements;
- Revenues from running costs appropriations and from proceeds deemed appropriated under section 35 of the [Audit Act 1901](#); and
- Employees Expenses and Other [Administrative Expenses](#) incurred in providing goods and services.

#### ***Administered***

The Office administers, but does not control, certain resources on behalf of the Commonwealth. It is accountable for the transactions involving those administered resources, but does not have the discretion to deploy the resources for achievement of the Office's objectives. Transactions and balances relating to administered activities are disclosed separately in the various statements.

Items classified as Administered include -

- Administered [Fines and Costs](#) Receivables awarded to the Commonwealth;
- Administered Fines and Costs [Revenue](#) and Expenses;
- Payments to the States for judicial services, and
- Miscellaneous revenue collected and deposited into the CRF.

The purpose of the separation of administered and departmental items is to enable the assessment of administrative efficiency of the Office in providing goods and services. Administered items are distinguished from departmental items in the financial statements by shading.

(n) **Administered Bad and Doubtful Debts** - A significant amount of debts outstanding may not be recovered, as [fines and costs](#) may be converted by serving time in prison, by performing community service or similar provisions. A number of fines and costs will also be written off as unrecoverable. Bad debts are written off during the year in which they are identified. A provision for doubtful debts has been made based on historical trend from past years data. The provision and its basis is reassessed annually.

(o) **Allocation of Costs and Revenues, Assets and Liabilities to Office Sub Programs** - The Office reports under three sub programs - Prosecutions (which includes Corporate Prosecutions), Criminal Assets and Executive and Support (which includes Library and Information Technology services).

Direct costs have been allocated against the sub program which incurred these costs where possible. Common costs and/or services are charged to a "Common" sub program during the financial year and were apportioned amongst sub programs at the end of the financial year based on average staffing levels or accommodation occupied for each sub program.

SUB PROGRAM	Average Staffing levels	Average Staffing levels	Square Metres occupied	Square Metres occupied
	<b>1995-96</b>	1994-95	<b>1995-96</b>	1994-95
Prosecutions	<b>59.6%</b>	55.6%	<b>45.5%</b>	45.2%
Criminal Assets	<b>10.6%</b>	12.5%	<b>13.4%</b>	14.1%
Executive and Support	<b>29.8%</b>	31.9%	<b>41.1%</b>	40.7%
Total	<b>100.0%</b>	100.0 %	<b>100.0%</b>	100.0 %

(This apportionment does not include Corporate Prosecutions, as these costs are charged directly to Corporations, not Common.)

Due to the small size of the Office and the common use of most significant assets, this Office prepares only a single Balance Sheet. Therefore, the sub program dissection of items included in the Program Statement of Assets and Liabilities has been apportioned based on the estimated usage of resources of the Office as indicated by the proportion of staffing resources used by a program or accommodation occupied. This apportionment does include Corporate Prosecutions, due to the common use of Assets.

SUB PROGRAM	Average Staffing levels	Average Staffing levels	Square Metres occupied	Square Metres occupied
	<b>1995-96</b>	1994-95	<b>1995-96</b>	1994-95
Prosecutions	<b>67.4%</b>	65.1%	<b>55.8%</b>	55.2%

Criminal Assets	<b>8.5%</b>	9.6%	<b>10.9%</b>	11.5%
Executive and Support	<b>24.1%</b>	25.3%	<b>33.4%</b>	33.3%
Total	<b>100.0%</b>	100.0%	<b>100.0%</b>	100.0 %

(p) **Superannuation** - Staff contribute to the Commonwealth Superannuation Scheme and Public Sector Superannuation Scheme. Employer contributions amounting to \$ 3,042,160 (1994-95 \$3,018,267) in relation to these schemes have been expensed in these Financial Statements. Prior to 1995-96, the Office was not required to make employer contributions in relation to staff membership of these schemes. The costs of superannuation in 1994-95 was a '[Liability Assumed By Other Departments](#)'.

(p) **Superannuation (continued)**

No liability is shown for superannuation in the Statement of Assets and Liabilities as the employer contributions fully extinguish the accruing liability which is assumed by the Commonwealth.

Employer Superannuation Productivity Benefit contributions totalled \$496,548 (1994-95 \$484,940).

(q) **Resources received free of charge** - Resources received free of charge are recognised in the Operating Statement as [revenue](#) where the amounts can be reliably measured. Use of those resources is recognised as part of the Net Cost of Services.

(r) **Changes in Accounting Policy** - Administered [Fines and Costs](#) Receivables awarded to the Commonwealth for the first time include amounts ordered to be paid by way of reparation at the reporting date. These amounts are only written out of the DPP's books once it is confirmed that another Agency will be responsible for the collection of these monies. This is also the first year that Accrual figures for [Revenue](#) and Expenses have been included. These changes in accounting policies result in revenues for 1995-96 of \$3,874,280 versus [receipts](#) of \$2,057,356 and expenses of \$2,731,372 versus payments of \$402,338.



[Return to the Annual Report Table of Contents](#)



[Return to the DPP Home Page](#)



## Note 3

### Employee Expenses:

	1995-96	1994-95
	\$	\$
Salaries and wages	20,673,373	18,955,258
Superannuation	3,538,708	3,503,207
Provision for employee entitlements	2,783,670	3,071,220
<b>Total</b>	<b>26,995,751</b>	<b>25,529,685</b>



[Return to the Annual Report Table of Contents](#)



[Return to the DPP Home Page](#)



## Note 4

### Other Administrative Expenses:

	1995-96	1994-95
	\$	\$
Compensation and legal prosecutions costs	15,616,433	10,738,797
Property operating expenses	6,419,427	5,558,069
Provision for depreciation - property, plant and equipment	1,616,716	1,512,835
Provision for amortisation of leasehold improvements	302,563	421,207
Loss on Sale of Assets	7,794	Nil
Computer Expenses	820,029	1,170,857
Library Expenses	1,138,176	1,132,864
Other Expenses	3,876,368	4,403,341
<b>Total</b>	<b>29,797,506</b>	<b>24,937,970</b>

 [Return to the Annual Report Table of Contents](#)

 [Return to the DPP Home Page](#)



## Note 5

### Revenue :

The DPP does not charge users of the services it provides.

#### **Revenue from Independent Sources:**

Other revenue from independent sources is made up of grants received for DPP Law Enforcement Trust Project (refer note 25) and Section 35 monies received which relate to receivables of the financial year.

	1995-96	1994-95
Other revenue from independent sources:	\$	\$
DPP Law Enforcement Projects <a href="#">receipts</a>	Nil	11,570
Profits arising from the sale of non <a href="#">current</a> assets	Nil	211,638
Other Section 35 monies for receivables for the financial year	<b>31,364</b>	129,022
Total <a href="#">Revenue</a> from independent sources	<b>31,364</b>	352,230

The following items of revenue were included in the aggregate amount for Appropriations shown in the Operating Statement:

	1995-96	1994-95
	\$	\$
Parliamentary Appropriations carried over from preceding year	<b>4,297,000</b>	3,139,000



[Return to the Annual Report Table of Contents](#)



[Return to the DPP Home Page](#)



## Note 6

### Resources Received Free Of Charge:

The resources received free of charge which have been recognised in the Operating Statement are:

	1995-96	1994-95
	\$	\$
- Department of Finance		
Provision of accounting and payroll services	8,957	29,965
- Attorney Generals Department		
Provision of prosecutions and related services in Tasmania and the Northern Territory, by AGS	1,942,705	Nil #
- Australian National Audit Office		
Audit of the 1995/96 financial statements	90,000	102,500
<b>Total resources received free of charge</b>	<b>2,041,662</b>	<b>132,465</b>

# 1995-96 is the first year that the Australian Government Solicitor has provided details of the cost of prosecutions and criminal asset work carried out in Tasmania and the Northern Territory.

#### Services received free of charge but not recognised are:

- **Melbourne Magistrates Court** - Provision of offices and furniture
- **Australian Archives** - Storage and disposal facilities
- **State Prosecutors** - Conduct of minor prosecutions on behalf of the DPP in remote locations.



[Return to the Annual Report Table of Contents](#)



[Return to the DPP Home Page](#)







## Note 7

### Abnormal Revenue:

In 1995-96 this item represents the write back of accumulated depreciation for those assets whose useful life has been reassessed. All assets that had been fully depreciated or would be fully depreciated within the next 12 months were reassessed and an estimate made by DPP Officers as to the remaining useful life of the asset.

It also includes the capitalisation of software, computer equipment and artwork held by the Office, which had not previously been reported as part of the Offices Non [Current](#) Assets.

	1995-96	1994-95
Abnormal <a href="#">revenue</a> due to:	\$	\$
- Accumulated Depreciation written back on the reassessment of useful life of assets*	607,992	Nil
- Adjustment to Computer Asset holding reported previously	219,870	228,954
- Capitalisation of Software not previously reported	3,780	239,773
- Capitalisation of Artwork not previously reported	30,122	85,042
Total Abnormal <a href="#">Revenue</a>	861,764	553,769

\* Accumulated Depreciation written back can be split between the following asset categories : Computers \$306,771; Furniture \$ 85,560; Plant & Equipment \$ 215,661.



[Return to the Annual Report Table of Contents](#)



[Return to the DPP Home Page](#)



## Note 8

### Administered Expenses :

	1995-96	1994-95
	\$	\$
<a href="#">Fines and Costs</a>		
- Payments to Agencies	2,344,794	404,763
- Bad and Doubtful debts	386,578	1,143,926
Payments to the states		
- Payment to NSW for judicial services	Nil	150,000
<b>Total Administered Expenses</b>	<b>2,731,372</b>	<b>1,698,689</b>

 [Return to the Annual Report Table of Contents](#)

 [Return to the DPP Home Page](#)



## Note 9

### Administered Revenue:

	1995-96	1994-95
	\$	\$
Fines and Costs <a href="#">Revenue</a>	3,874,280	2,489,033
Proceeds of Crime	4,522	29,091
Miscellaneous Revenue:		
- Rental Rebate *	311,012	622,024
- Other	84,988	59,178
Net Administered Revenue	4,274,802	3,199,326
* This amount reflects rental rebate received in respect of a property lease.		



[Return to the Annual Report Table of Contents](#)



[Return to the DPP Home Page](#)



## Note 10

### Act Of Grace Payments, Waivers And Amounts Written-Off :

The following details are furnished in relation to amounts written off by the Office during the financial year 1995-96 under sub-section 70C(1) of the [Audit Act 1901](#) (3,484 amounts totalling \$997,491 were written off in 1994-95).

#### In respect of departmental items:

	Number	\$
(i) Losses or deficiencies of public moneys	Nil	Nil
(ii) Irrecoverable amounts of <a href="#">revenue</a>	Nil	Nil
(iii) Irrecoverable debts and overpayments	Nil	Nil
(iv) Amounts of revenue, or debts or overpayments, the recovery of which would, in the opinion of the Minister, be uneconomical	Nil	Nil
(v) The value of lost, deficient, condemned, unserviceable or obsolete stores	43	16,248
<b>Total</b>	<b>43</b>	<b>16,248</b>

<b>In respect of Administered items.</b>		
	Number	\$
(ii) Irrecoverable amounts of <a href="#">revenue</a>	115	175,702
(iii) Irrecoverable debts and overpayments	432	55,458
(iv) Amounts of revenue, or debts or overpayments, the recovery of which would, in the opinion of the Minister, be uneconomical	196	99,333

Total	<b>743</b>	<b>330,493</b>

No payments were made during the financial year 1995-96 pursuant to authorisations given under Section 34A(1) of the [Audit Act 1901](#) ( Nil in 1994-95).

Three waivers of \$965 due to the Commonwealth were made during the financial year 1995-96 pursuant to subsection 70C(2) of the [Audit Act 1901](#) (1 amount totalling \$300 was waived in 1994-95), these waivers relate to Administered [Fines and Costs](#).

### **LOSSES AND DEFICIENCIES IN PUBLIC MONEYS AND OTHER PROPERTY**

During 1995-96 this office had two cases involving the loss of moneys. The amount of \$210.80 was not recovered.

During 1994-95 this office had one case involving the loss of moneys. No relief was provided or sought under Part XIAA of the [Audit Act 1901](#). The amount of \$5,948.60 was recovered by this Office.



[Return to the Annual Report Table of Contents](#)



[Return to the DPP Home Page](#)



## Note 11

### Cash - Departmental:

	1995-96	1994-95
	\$	\$
<u>Cash at Bank -</u>		
Legal Advance accounts	116,372	55,440
Collectors <a href="#">Receipts</a> account	1,800	1,112
<u>Cash on Hand -</u>		
Legal Advance accounts	4,000	3,139
Other Advance accounts, cash floats	42,210	38,675
<u>Cash on Trust - Held in Commonwealth Public Account</u>		
DPP Law Enforcement Projects	12,267	50,926
<b>Total Cash at bank and on hand</b>	<b>176,649</b>	<b>149,292</b>

The DPP Law Enforcement Project Trust Account was established on 25 March 1993. Monies in this Trust Account are to be expended on law enforcement and drug rehabilitation and education projects for the purpose of Section 34D of the *Proceeds of Crime Act 1987*. Money held in the account have been granted for the purchase of computer aided court presentation systems and to host a national criminal assets conference.



[Return to the Annual Report Table of Contents](#)



[Return to the DPP Home Page](#)



## Note 12

### Receivables - Departmental:

#### (a) Trade Debtors

	1995-96	1994-95
	\$	\$
<b>Current :</b>		
Other Commonwealth entities	592	Nil
Other entities	7,400	797
Less doubtful debts	Nil	Nil
	7,992	797
<b>Non-Current :</b>		
Other Entities	Nil	Nil
Less doubtful debts	Nil	Nil
	Nil	Nil
<b>Total Net Receivables</b>	<b>7,992</b>	<b>797</b>

#### (b) Other Debtors:

	1995-96	1994-95
	\$	\$
<b>Current :</b>		
Other Entities	187	2,101
Less doubtful debts	Nil	Nil
	187	2,101



<b>Non-Current :</b>		
Other Entities	<b>Nil</b>	Nil
Less doubtful debts	<b>Nil</b>	Nil
	<b>Nil</b>	Nil
<b>Total Net Receivables</b>	<b>187</b>	2,101

**(c) Age Analysis - Receivables DPP**

<b>Gross Receivables</b>	<b>8,179</b>	2,898
Not overdue	<b>Nil</b>	968
Overdue less than 30 days	<b>8,179</b>	1,806
Overdue 30 to 60 days	<b>Nil</b>	124
Overdue more than 60 days	<b>Nil</b>	Nil
<b>Total Receivables</b>	<b>8,179</b>	2,898

**(d) Write-offs 1994-95**

No debts were written-off during 1995-96 (nil in 1994-95):



[Return to the Annual Report Table of Contents](#)



[Return to the DPP Home Page](#)



## Note 13

### Other Current Assets :

	1995-96	1994-95
	\$	\$
<a href="#">Prepayments</a>	1,084,950	598,279
Fitout Advance*	1,184,132	Nil
<b>Total Other <a href="#">Current</a> Assets</b>	<b>2,269,082</b>	<b>598,279</b>

\*Fitout Advance relates to monies remaining in trust with Australian Property Group for the fitout of the Head Office of the Office of the Director of Public Prosecutions as at 30 June 1996.



[Return to the Annual Report Table of Contents](#)



[Return to the DPP Home Page](#)



## Note 14

### Property, Plant And Equipment :

	1995-96	1994-95
<b>Closing Balance 30 June :</b>	\$	\$
<b>1. Items at cost :</b>		
Computers and Software at cost	6,633,084	6,246,792
Less accumulated depreciation	3,907,215	3,129,117
	2,725,869	3,117,675
Furniture at cost	391,135	391,108
Less accumulated depreciation	223,560	264,990
	167,575	126,118
Plant and Equipment at cost	1,818,054	1,729,337
Less accumulated depreciation	1,048,912	1,107,202
	769,142	622,135
Fitout Work in Progress*	1,284,623	Nil
Fitout at cost	2,565,874	2,506,927
Less accumulated amortisation	1,203,491	900,928
	2,647,006	1,605,999
Artwork at Cost	165,745	133,524
<b>Sub-total Items at cost</b>	<b>12,858,515</b>	<b>11,007,688</b>
Less accumulated depreciation	6,383,178	5,402,237
<b>Sub-total Net Items at Cost</b>	<b>6,475,337</b>	<b>5,605,451</b>
<b>2. Items at valuation :</b>		
Library Holdings at valuation	1,024,275	1,023,475

<b>Sub-total Items at valuation</b>	<b>1,024,275</b>	1,023,475
<b>Total Property, Plant and Equipment</b>	<b>13,882,790</b>	12,031,163
Less accumulated depreciation	<b>6,383,178</b>	5,402,237
<b>Net Property, Plant and Equipment</b>	<b>7,499,612</b>	6,628,926

\* Fitout Work in Progress relates to construction completed as at the 30 June 1996 on Head Office.



[Return to the Annual Report Table of Contents](#)



[Return to the DPP Home Page](#)



## Note 15

### Creditors And Accruals:

	1995-96	1994-95
	\$	\$
Trade Creditors and Accruals	3,947,777	1,442,974
Other Creditors and Accruals	2,102	1,470
Salaries Accruals	192,592	281,172
<b>Total Creditors and Accruals</b>	<b>4,142,471</b>	<b>1,725,616</b>

 [Return to the Annual Report Table of Contents](#)

 [Return to the DPP Home Page](#)



## Note 16

### Provisions:

	1995-96	1994-95
<b>Current Provisions:</b>	\$	\$
Recreation Leave	1,800,000	1,800,000
Long Service Leave	289,847	294,573
Performance Pay	275,041	638,745
<b>Total Current Provisions</b>	<b>2,364,888</b>	<b>2,733,318</b>
<b>Non-Current Provisions:</b>		
Recreation Leave	788,656	739,665
Long Service Leave	3,939,906	3,595,257
<b>Total Non-current Provisions</b>	<b>4,728,562</b>	<b>4,334,922</b>
<b>Total Provisions</b>	<b>7,093,450</b>	<b>7,068,240</b>



[Return to the Annual Report Table of Contents](#)



[Return to the DPP Home Page](#)



## Note 17

### Other Current Liabilities:

The following deferred lease expenses exist for property leases currently held by this office.

	1995-96	1994-95
	\$	\$
Deferred Lease expenses	5,127,881	3,255,495
<b>Total Other <u>Current</u> Liabilities</b>	<b>5,127,881</b>	<b>3,255,495</b>

Amounts are payable as follows after the end of the reporting period for accommodation leases:

First year \$	Second Year \$	Third to Fifth Years \$	Sixth and Subsequent Years \$	Total \$
5,576,290	6,234,901	18,151,394	19,119,452	49,082,037



[Return to the Annual Report Table of Contents](#)



[Return to the DPP Home Page](#)



## Note 18

### Administered Assets :

Administered Assets comprises Cash held in <a href="#">Fines and Costs</a> bank accounts, Fines and Costs monies held in the Collectors <a href="#">Receipts</a> Account pending transfer to Consolidated <a href="#">Revenue</a> , and Receivables due to the Commonwealth from successful prosecutions by the DPP.		
<b>Administered cash :</b>	<b>1995-96</b>	<b>1994-95</b>
	\$	\$
<u>Cash at Bank</u>		
Collectors Receipts Account	Nil	24,376
<u>Cash on Trust - Held outside Commonwealth Public Account</u>		
Fines and Costs - cash at bank	66,465	42,352
<a href="#">Fines and Costs</a> - cash on hand	Nil	Nil
Total Administered Cash at bank and on hand	66,465	66,728

<b>NOTE 18 continued</b>		
<b>Administered Receivables :</b>		
	<b>1995-96</b>	<b>1994-95</b>
	\$	\$
<b>Current :</b>		
Fines and Costs due to the DPP	6,110,262	5,593,468



Less doubtful debts	1,397,510	1,625,557
	4,712,752	3,967,911
Fines and Costs due to other CPA Agencies	1,715,068	1,177,330
Less doubtful debts	23,852	99,338
	1,691,216	1,077,992
<u>Fines and Costs</u> due to Non-CPA Agencies	152,779	196,644
Less doubtful debts	16,703	24,502
	136,076	172,142
Other Receivables - Rental Rebate	Nil	311,012
Net <u>Current</u> Administered Receivables	6,540,044	5,529,057
<b>Non-Current :</b>		
Fines and Costs due to the DPP	322,324	147,654
Less doubtful debts	73,721	42,911
	248,603	104,743
Fines and Costs due to other CPA Agencies	82,052	123,538
Less doubtful debts	1,141	10,424
	80,911	113,114
<u>Fines and Costs</u> due to Non-CPA Agencies	49,402	54,046
Less doubtful debts	5,401	6,734
	44,001	47,312
Net Non-Current Administered Receivables	373,515	265,169
<b>Total Net Administered Receivables</b>	<b>6,913,559</b>	<b>5,794,226</b>

<b>NOTE 18 continued</b>		
<b>Age Analysis - Administered Receivables</b>		

	1995-96	1994-95
	\$	\$
<b>Gross Administered Receivables</b>	<b>8,431,887</b>	7,292,680
Not overdue	5,152,452	1,316,037
Overdue less than 30 days	262,263	263,414
Overdue 30 to 60 days	183,628	171,099
Overdue more than 60 days	2,833,544	5,542,130
<b>Total Administered Receivables</b>	<b>8,431,887</b>	7,292,680

#### Write-offs 1995-96 - Administered Receivables

A significant amount of debts outstanding may not be recovered, as [fines and costs](#) may be converted by serving time in prison, by performing community service or similar provisions. A number of fines and costs will also be written off as irrecoverable. During 1995-96 the following amounts were written out of the books:

Agency / Type	DPP	CPA(Non DPP)	NON-CPA	TOTAL
Prison Sentence	214,057	2,497	280	216,834
Community Service	126,984	1,533	908	129,425
Irrecoverable	305,309	13,671	11,513	330,493
Waivers	23	Nil	942	965
<b>Total Write-offs</b>	<b>646,373</b>	<b>17,701</b>	<b>13,643</b>	<b>677,717</b>



[Return to the Annual Report Table of Contents](#)



[Return to the DPP Home Page](#)



## Note 19

### Administered Liabilities :

The [liability](#) due to other agencies for 1995-96 from the [Fines and Costs](#) as at 30 June 1996 is based on historical data. The calculated liability for 1995-96 is \$ 1,952,204 (\$9,648 in 1994-95).

	<b>1995-96</b>	<b>1994-95</b>
	\$	\$
Fines and Costs	<b>1,952,204</b>	9,648
<b>Total Administered Liabilities</b>	<b>1,952,204</b>	9,648

---

 [Return to the Annual Report Table of Contents](#)

 [Return to the DPP Home Page](#)

---



## Note 20

### Fines And Costs Trust Account:

**Legal Authority** - The accounts were opened in accordance with Section 20 of the Finance Directions by the Director as a delegate of the Minister for Finance.

**Purpose of Account** - The purpose of the account is to process [fines and costs](#) awarded in Commonwealth prosecutions. Such moneys are collected by State Courts and forwarded regularly to the DPP. In 1993-94, moneys collected were initially banked to these accounts and then disbursed to either DPP [revenue](#) accounts (see Statement of Transactions by Fund) for matters for which the DPP has administrative responsibility, mainly Crimes Act matters, or to other Departments or Agencies for Acts administered by them (eg Taxation, Social Security, etc).

As from 1 July 1994 the DPP took over responsibility for receivables previously due to other agencies, except in respect of matters administered by non-budget funded agencies (eg Federal Airports Corporation, etc). All [Fines and Costs receipts](#) and payments will be recorded in the DPP's Operating Statement as administered items. The balance in the Fines and Costs Trust account will be recorded as an administered asset in the Statement of Assets and Liabilities.

	1995-96	1994-95
	\$	\$
<b>Opening Balance 1 July</b>	42,352	132,275
<b>Receipts</b>	2,057,256	2,489,033
<b><a href="#">Expenditure</a></b>	2,033,143	2,578,956
<b>Closing Balance 30 June</b>	66,465	42,352



[Return to the Annual Report Table of Contents](#)



[Return to the DPP Home Page](#)



## Note 21

### Residual Interest In Assets:

	1995-96	1994-95
	\$'000	\$'000
<b>Opening Balance</b>		
Accumulated Surplus (Deficit)	(4,670)	(1,068)
<b>Plus: Additions</b>		
Operating Result	(1,741)	(3,535)
Adjustment to Opening Surplus	Nil	(67)
<b>Closing balance</b>		
Residual Interest in Assets	(6,411)	(4,670)



[Return to the Annual Report Table of Contents](#)



[Return to the DPP Home Page](#)



## Note 22

### Cash Flow Reconciliation :

	1995-96	1994-95
	\$	\$
Net Cost of Services	56,761,892	50,115,426
<a href="#">Revenue</a> from Government	(55,021,568)	(46,581,104)
Depreciation / amortisation	(1,919,279)	(1,934,042)
Profit/Loss on sale of non-current assets	(7,794)	211,638
Capitalisation of Non-current Assets not previously reported	30,351	324,815
Adjustment to Non-current assets previously reported	223,420	228,954
Accumulated Depreciation Written Back	607,992	Nil
Decrease in Receivables	5,281	(2,704)
Increase/Decrease in other assets	486,671	111,240
Decrease/Increase in Creditors	(2,180,649)	284,415
Increase in Provisions	(25,209)	(131,264)
Increase/Decrease in other liabilities	(1,872,386)	(3,238,098)
Net cash provided by Operating Activities	(2,911,278)	(610,724)



[Return to the Annual Report Table of Contents](#)



[Return to the DPP Home Page](#)



## Note 23

### Receipts To The Consolidated Revenue Fund:

	<u>Receipts</u>	Refunds	Net Receipts
	\$	\$	\$
<u>Revenue</u>			
- Proceeds of Crime Legislation	4,522	Nil	4,522
Receipts offset against <u>outlays</u>			
- Section 35 of the <u>Audit Act 1901</u>	63,169	Nil	63,169
- Miscellaneous	396,030	30	396,000
Administered Receipts			
- <u>Fines and Costs</u>	1,628,648	6,477	1,622,171
<b>Total Receipts</b>	<b>2,092,369</b>	<b>6,507</b>	<b>2,085,862</b>



[Return to the Annual Report Table of Contents](#)



[Return to the DPP Home Page](#)



## Note 24

### Details Of Expenditure From Annual Appropriations :

	1996-97	1995-96	1995-96
	Budget	Actual	<a href="#">Appropriation</a>
	\$	\$	\$
APPROPRIATION ACT No's. 1 and 3			
<b>Division 133 - Director of Public Prosecutions</b>			
1. Running Costs -	<b>58,276,000</b>	52,219,971	58,129,169
Annotated Appropriation			
2. Other Services			
01. Payment to NSW court administration	Nil	Nil	150,000
	<b>58,276,000</b>	52,219,971(i)	58,279,169

#### **RUNNING COSTS (ANNOTATED APPROPRIATION DIVISION 133)**

This [appropriation](#) was annotated pursuant to section 35 of the [Audit Act 1901](#) to allow the crediting of [receipts](#) from contributions for senior officers official vehicles, contributions towards the cost of semi-official telephones and receipts from the sale of surplus and/or obsolete assets.

The Annotated Appropriation operated as follows -

	Appropriation	Section 35		Total		<a href="#">Expenditure</a>
	- Division 133	Receipts		<a href="#">Appropriation</a>		
	\$	\$		\$		\$
<b>1995-96</b>	<b>58,216,000</b>	<b>63,169</b>		<b>58,279,169</b>		<b>52,219,971(ii)</b>
1994-95	54,165,000	343,365		54,508,365		43,369,967



### **Explanation of Material Variances:**

- (i) The underspending against the 1995-96 budget was primarily due to carry-over of funds due to the deferral of aspects of the IT re-equipment while software is evaluated and the reserving of funds to meet spending [commitments](#) in 1996-97.
- (ii) The increase in [expenditure](#) over 1994-95 was primarily due to wage awards and CPI increases, the relocation of our Canberra Office, a number of major cases and an ongoing Information Technology re-equipment program. No funds have been provided for war crimes in prosecutions from 1994-95.



[Return to the Annual Report Table of Contents](#)



[Return to the DPP Home Page](#)

---



## Note 25

### Trust Fund :

#### DPP Services, Other Government and Non Departmental Bodies

- . Legal Authority - [Audit Act 1901](#), Section 60.
- . Purpose - payment of costs in connection with services performed on behalf of other governments and non-departmental bodies (COMCARE expenses).

	1995-96	1995-96	1994-95
	Actual	Budget	Actual
	\$	\$	\$
<a href="#">Receipts</a> and <a href="#">Expenditure</a> -			
Opening balance 1 July	24,951		12,100
Receipts	45,611	114,000	91,969
Expenditure	50,825	114,000	79,118
Closing balance 30 June	19,737		24,951

(The Trust Account operates for the purpose of receiving, from Comcare, amounts payable to employees under determinations in accordance with the *Safety, Rehabilitation and Compensation Act 1988*).

The DPP pays an annual premium to Comcare for workers compensation.

Until a determination is made by Comcare, this Office makes payments from the salary notional item to the employee. When Comcare makes a determination in respect of a case they pay monies into the Trust Account to meet the determined costs. Upon receiving a determination and funds from Comcare, the Office processes a journal to credit that amount back to salary [expenditure](#) and to debit the Trust Account.

The balance of \$19,737 as at 30 June 1996 (\$24,951 as at 30 June 1995) for the Trust Account is the total of amounts received from Comcare to be paid to claimants in accordance with determinations.

#### DPP Law Enforcement Projects

- . Legal Authority - [Audit Act 1901](#), Section 62 A
- . Purpose - for the expenditure of moneys on law enforcement projects selected for the

purpose of section 34D of the Proceeds of Crime Act 1987.

<a href="#">Receipts</a> and <a href="#">Expenditure</a> -			
Opening balance 1 July	<b>50,926</b>		179,264
Receipts	<b>Nil</b>	20,000	11,570
Expenditure	<b>38,659</b>	20,000	139,908
Closing balance 30 June (Note 11)	<b>12,267</b>		50,926



[Return to the Annual Report Table of Contents](#)



[Return to the DPP Home Page](#)



## Note 26

### Agreements Equally Proportionately Unperformed:

#### (a) Capital Expenditure Commitments :

The DPP had capital commitments outstanding at 30 June 1996 of \$ 1,275 (nil at 30 June 1995).

Item	First year \$	Second Year \$	Third to Fifth Years \$	Sixth and Subsequent Years \$	Total \$
Plant & Equipment	1,275				1,275
Total	1,275				1,275

#### (b) Other Commitments :

The DPP has entered into commitments as at 30 June 1996 of \$ 7,207,197 (\$21,098,471 as at 30 June 1995) and are payable as follows after the reporting period:

Item	First year \$	Second Year \$	Third to Fifth Years \$	Sixth and Subsequent Years \$	Total \$
Plant & Equipment	10,484				10,484
ADP	31,848				31,848
Library	180,679				180,679
Other	26,367				26,367
Legal	5,597,219	1,360,600			6,957,819
Total	5,846,597	1,360,600			7,207,197

In 1994-95 Other Commitments consisted primarily of a property lease the Office intended to enter into, in 1995-96 this is recorded under Note 17 Other Current Liabilities.

#### (c) Contracted Expenditure:

DPP also had \$976,808 contracted liabilities which remain unperformed at 30 June 1996. (\$255,217 at 30 June 1995). Amounts are payable as follows after the end of the reporting period:

Item	First year \$	Second Year \$	Third to	Sixth and Subsequent	Total \$
------	---------------	----------------	----------	----------------------	----------

				<b>Fifth Years \$</b>	
Plant & Equipment	130,702				130,702
ADP	24,084				24,084
Other	721,927				721,927
Legal	100,095				100,095
Total	976,808				976,808

---

 [Return to the Annual Report Table of Contents](#)

 [Return to the DPP Home Page](#)

---



## Note 26

### Agreements Equally Proportionately Unperformed:

#### (a) Capital Expenditure Commitments :

The DPP had capital commitments outstanding at 30 June 1996 of \$ 1,275 (nil at 30 June 1995).

Item	First year \$	Second Year \$	Third to Fifth Years \$	Sixth and Subsequent Years \$	Total \$
Plant & Equipment	1,275				1,275
Total	1,275				1,275

#### (b) Other Commitments :

The DPP has entered into commitments as at 30 June 1996 of \$ 7,207,197 (\$21,098,471 as at 30 June 1995) and are payable as follows after the reporting period:

Item	First year \$	Second Year \$	Third to Fifth Years \$	Sixth and Subsequent Years \$	Total \$
Plant & Equipment	10,484				10,484
ADP	31,848				31,848
Library	180,679				180,679
Other	26,367				26,367
Legal	5,597,219	1,360,600			6,957,819
Total	5,846,597	1,360,600			7,207,197

In 1994-95 Other Commitments consisted primarily of a property lease the Office intended to enter into, in 1995-96 this is recorded under Note 17 Other Current Liabilities.

#### (c) Contracted Expenditure:

DPP also had \$976,808 contracted liabilities which remain unperformed at 30 June 1996. (\$255,217 at 30 June 1995). Amounts are payable as follows after the end of the reporting period:

Item	First year \$	Second Year \$	Third to	Sixth and Subsequent	Total \$
------	---------------	----------------	----------	----------------------	----------

				<b>Fifth Years \$</b>	<b>Years \$</b>	
Plant & Equipment	130,702					130,702
ADP	24,084					24,084
Other	721,927					721,927
Legal	100,095					100,095
Total	976,808					976,808



[Return to the Annual Report Table of Contents](#)



[Return to the DPP Home Page](#)



## Note 27

### Liabilities Not Recognised:

If a matter being prosecuted by the DPP is defended successfully, the court may order that the DPP meet certain costs incurred by the defence. Costs so awarded are met from DPP or client organisations [annual appropriations](#) for Legal Expenses.

Although costs have been awarded against the DPP and will continue to be awarded from time to time, the DPP is unable to declare an estimate of liabilities not recognised due to the uncertainty of the outcome of matters, but more particularly to the sensitivity of the information related to matters still before the courts.



[Return to the Annual Report Table of Contents](#)



[Return to the DPP Home Page](#)





## Note 28

### Guarantees And Undertakings :

If a matter is being prosecuted by the DPP and assets are frozen under the *Proceeds of Crime Act*, this Office gives an undertaking against potential losses in respect of assets administered by the Commonwealth. If the related prosecution is unsuccessful, damages can be awarded against the DPP. Damages so awarded are met from the DPP's [annual appropriations](#) for Legal Expenses.

Although damages have been awarded against the DPP and will continue to be awarded from time to time, the DPP is unable to declare an estimate of such undertakings due to the uncertainty of the outcome of matters, but more particularly to the sensitivity of the information related to matters still before the courts.



[Return to the Annual Report Table of Contents](#)



[Return to the DPP Home Page](#)



## Note 29

### Executive's Remuneration :

In relation to the \$10,000 band of fixed remuneration that commences at \$100,000 and each successive \$10,000 band, the number of executive officers whose total fixed remuneration in connection with the management of the affairs of the Office of the Director of Public Prosecutions for the reporting period are as follows:

	1995-96	1994-95
	Number	Number
Fixed remuneration		
\$100,000 to \$110,000	24	1
\$110,001 to \$120,000	1	5
\$120,001 to \$130,000	3	Nil
\$130,001 to \$140,000	1	Nil
\$140,001 to \$150,000	Nil	2
\$150,001 to \$160,000	1	1
\$160,001 to \$170,000	Nil	Nil
\$170,001 to \$180,000	1	Nil
\$180,001 to \$190,000	Nil	Nil
\$190,001 to \$200,000	Nil	Nil
\$200,001 to \$210,000	Nil	1
\$210,001 to \$220,000	1	Nil

The aggregate fixed remuneration of the executives identified above is \$3,735,199, (\$1,335,524 in 1994-95).

The aggregate performance pay earned by the executives identified above is \$162,385 (\$56,857 in 1994-95).



[Return to the Annual Report Table of Contents](#)



[Return to the DPP Home Page](#)



## **Note 30**

### **Services Provided By The Auditor General:**

The notional fee for services provided by the Australian National Audit Office in relation to the audit of the 1995-96 Financial Statement is estimated at \$90,000 (\$102,500 was the notional cost for the audit of the 1994-95 Financial Statement).

The ANAO is recorded in Note 6 as having provided resources free of charge to the DPP in 1995-96. No other benefits were received by the Australian National Audit Office.



[Return to the Annual Report Table of Contents](#)



[Return to the DPP Home Page](#)

---



## Note 30

### Services Provided By The Auditor General:

The notional fee for services provided by the Australian National Audit Office in relation to the audit of the 1995-96 Financial Statement is estimated at \$90,000 (\$102,500 was the notional cost for the audit of the 1994-95 Financial Statement).

The ANAO is recorded in Note 6 as having provided resources free of charge to the DPP in 1995-96. No other benefits were received by the Australian National Audit Office.



[Return to the Annual Report Table of Contents](#)



[Return to the DPP Home Page](#)

---



## Note 31

### Liabilities Assumed By Other Departments :

Liabilities assumed by other departments represents the [liability](#) for the present value of the Commonwealth's share of future Superannuation payments. Departments were funded for this in 1995-96, therefore there are no liabilities assumed by other departments in 1995-96 (\$3,018,267 in 1994-95).



[Return to the Annual Report Table of Contents](#)



[Return to the DPP Home Page](#)



## Note 32

### Events Occurring After Balance Date:

As a result of the 1996-97 budget the Office faces a reduction in running costs and accordingly it is anticipated that there will be a reduction in staff numbers to help meet the reduced funding. At balance date, neither individual positions nor officers who may be affected by this decision had been identified.

Subsequent to balance date costs of \$600,000 were awarded against the DPP as a result of one of its unsuccessful prosecutions.



[Return to the Annual Report Table of Contents](#)



[Return to the DPP Home Page](#)

---